

Owner's Manual

Please read before using this unit.

DVD/CD Player with Video Cassette Recorder CMWD2206 A

MAGNAVOX

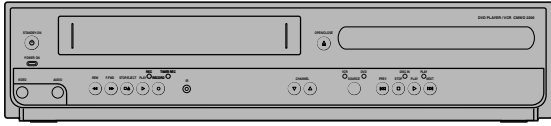

Supplied Accessories

Remote control (NB179UD) with two AA (1.5V) batteries



RF cable (WPZ0901TM002 / WPZ0901TM005)

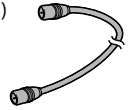

Audio/Video cables (WPZ0102TM018 / WPZ0102LTE01 / WPZ102SCP001)

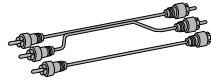

Owner's Manual (1VMN28734)



If you need additional operating assistance after reading this owner's manual, please call

TOLL FREE : 1-800-605-8610

or visit our web site at

www.magnavox.com/support

Contents

Precautions

■ Safety Instructions	2
Moisture Condensation Warning	4
About Copyright	4
Symbols Used in This Manual	4
Maintenance	4
■ About the Video Cassettes and Discs	5
Playable Video Cassettes	5
Playable Discs	5
Unplayable Discs	5

Setup

■ Connections	6
RF Output Channel	6
Hint for Cable Box or Satellite Box	6
Connection to an Audio System	6
Connection to a TV	7
■ Preparation for Use	8
Turn on the Unit for the First Time	8
To Add or Delete Channels	8
Clock Setup	8
■ Function Overview	9
Front Panel Indicator	9
VCR / DVD Switching	9
Front & Rear Terminals	9
Remote Control	10
Installing the Batteries for the Remote Control	10

VCR Functions

■ Playback	11
■ Other Operations	11
Index Search	11
Time Search	11
Auto Repeat	12

■ Recording	12
Recording & OTR (One Touch Recording)	12
Timer Recording	12
Hints for OTR and Timer Recording	13
Copying a Video Tape	14

DVD Functions

■ Playback	15
■ Search Functions	16
Using Track Search	16
Using Title / Chapter Search	16
Using Time Search	16
■ On-Screen Display	17
■ Repeat / Random / Programmed Playback	18
Repeat Playback / Repeat A-B Playback	18
Random Playback / Programmed Playback	18
■ Special Settings	19
Subtitle Language / Audio Language	19
Camera Angles / Black Level Setting	19
Stereo Sound Mode / Virtual Surround	19
■ DVD Setup	20
LANGUAGE Setting	20
DISPLAY Setting	21
AUDIO Setting	21
PARENTAL Setting	22
OTHERS Setting	22
Reset to the Default Setting (Except for PARENTAL Setting)	23

Information

■ Troubleshooting Guide	23
■ Specifications	24
■ Language Code List	24
■ Limited Warranty	24
■ Quick Use Guide	25

Basic TV Connection

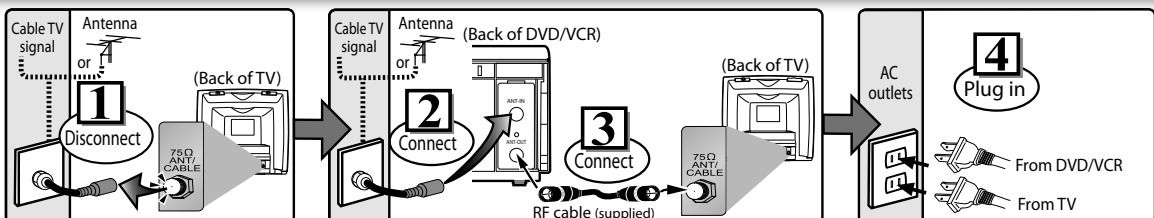

5 Please refer to "Connections" on page 6.

Precautions

Safety Instructions

The model and serial numbers of this unit may be found on the cabinet.
You should record and retain those numbers for future reference.

Model No.: _____
Serial No.: _____

WARNING: TO REDUCE THE RISK OF FIRE OR ELECTRIC SHOCK, DO NOT EXPOSE THIS APPARATUS TO RAIN OR MOISTURE.
APPARATUS SHALL NOT BE EXPOSED TO DRIPPING OR SPLASHING AND NO OBJECTS FILLED WITH LIQUIDS, SUCH AS VASES, SHALL BE PLACED ON THE APPARATUS.



CAUTION
RISK OF ELECTRIC SHOCK
DO NOT OPEN



CAUTION: TO REDUCE THE RISK OF ELECTRIC SHOCK, DO NOT REMOVE COVER (OR BACK). NO USER SERVICEABLE PARTS INSIDE. REFER SERVICING TO QUALIFIED SERVICE PERSONNEL.



The lightning flash with arrowhead symbol, within an equilateral triangle, is intended to alert the user to the presence of uninsulated "dangerous voltage" within the product's enclosure that may be of sufficient magnitude to constitute a risk of electric shock to persons.



The exclamation point within an equilateral triangle is intended to alert the user to the presence of important operating and maintenance (servicing) instructions in the literature accompanying the appliance.

The important note is located on the rear or bottom of the cabinet.



The symbol for CLASS II (Double Insulation)

IMPORTANT SAFETY INSTRUCTIONS

1. Read these instructions.
2. Keep these instructions.
3. Heed all warnings.
4. Follow all instructions.
5. Do not use this apparatus near water.
6. Clean only with dry cloth.
7. Do not block any ventilation openings. Install in accordance with the manufacturer's instructions.
8. Do not install near any heat sources such as radiators, heat registers, stoves, or other apparatus (including amplifiers) that produce heat.
9. Do not defeat the safety purpose of the polarized or grounding-type plug. A polarized plug has two blades with one wider than the other. A grounding type plug has two blades and a third grounding prong. The wide blade or the third prong are provided for your safety. If the provided plug does not fit into your outlet, consult an electrician for replacement of the obsolete outlet.
10. Protect the power cord from being walked on or pinched particularly at plugs, convenience receptacles, and the point where they exit from the apparatus.
11. Only use attachments/accessories specified by the manufacturer.
12. Use only with the cart, stand, tripod, bracket, or table specified by the manufacturer, or sold with the apparatus. When a cart is used, use caution when moving the cart/apparatus combination to avoid injury from tip-over.
13. Unplug this apparatus during lightning storms or when unused for long periods of time.
14. Refer all servicing to qualified service personnel. Servicing is required when the apparatus has been damaged in any way, such as power-supply cord or plug is damaged, liquid has been spilled or objects have fallen into the apparatus, the apparatus has been exposed to rain or moisture, does not operate normally, or has been dropped.



This Class B digital apparatus complies with Canadian ICES-003.

Disconnect the mains plug to shut off when find trouble or not in use. The mains plug shall remain readily operable.

CAUTION: Danger of explosion if battery is incorrectly replaced. Replace only with the same or equivalent type.
WARNING: Batteries (Battery pack or battery installed) shall not be exposed to excessive heat such as sunshine, fire, or the like.

LASER SAFETY

This apparatus employs a laser. Only a qualified service person should remove the cover or attempt to service this apparatus, due to possible eye injury.

CAUTION: Use of controls or adjustments or performance of procedures other than those specified herein may result in hazardous radiation exposure.

CAUTION: Visible and invisible laser radiation when open and interlocks defeated. Do not stare into beam.

LOCATION: Inside, near the deck mechanism.

IMPORTANT COPYRIGHT INFORMATION

Unauthorized copying, broadcasting, public performance and lending of discs are prohibited. This product incorporates copyright protection technology that is protected by U.S. patents and other intellectual property rights. Use of this copyright protection technology must be authorized by Macrovision, and is intended for home and other limited viewing uses only unless otherwise authorized by Macrovision. Reverse engineering or disassembly is prohibited.

Do not place the unit on the furniture that is capable of being tilted by a child and an adult leaning, pulling, standing or climbing on it. A falling unit can cause serious injury or even death.

To Avoid the Hazards of Electrical Shock and Fire

- Do not handle the power cord with wet hands.
- Do not pull on the power cord when disconnecting it from an AC outlet. Grasp it by the plug.
- Do not put your fingers or objects into the unit.

Location and Handling

- Do not install the unit in direct sunlight, near strong magnetic fields, or in a place subject to dust or strong vibration.
- Avoid a place with drastic temperature changes.
- Install the unit in a horizontal and stable position. Do not place anything directly on top or bottom of the unit. Depending on your external devices, noise or disturbance of the picture and/or sound may be generated if the unit is placed too close to them. In this case, please ensure enough space between the external devices and the unit.
- Depending on the environment, the temperature of this unit may increase slightly. This is not a malfunction.
- Be sure to remove the disc and unplug the AC power cord from the outlet before carrying the unit.

Dew Condensation Warning

- Dew condensation may form inside the unit in the following conditions. If so, do not use this unit at least for a few hours until its inside gets dry.
 - The unit is moved from a cold place to a warm place.
 - Under conditions of high humidity.
 - After heating a cold room.

Note about Recycling

- This unit's packaging materials are recyclable and can be reused. Please dispose of any materials in accordance with your local recycling regulations.
- Batteries should never be thrown away or incinerated but disposed of in accordance with your local regulations concerning chemical wastes.

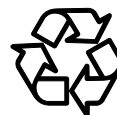

Notice for Progressive Scan Output

- Consumers should note that not all high definition television sets are fully compatible with this product and may cause artifacts to be displayed in the picture. In case of picture problems with 525(480) progressive scan output, it is recommended that the user switch the connection to the 'standard definition' output. If there are questions regarding your TV set compatibility with this 525p(480p) DVD player, please contact our customer service center.

Moisture Condensation Warning

Moisture may form inside this unit under the following conditions:

- Immediately after a heater is turned on.
- In a steamy or humid room.
- When this unit is suddenly moved from a cold to warm environment.

If moisture forms inside this unit, it may not operate properly or damage the cassette tape. In such case, do not use this unit at least for 2 hours until its inside gets dry.

About Copyright

Unauthorized copying, broadcasting, public performance and lending of discs are prohibited.

This product incorporates copyright protection technology that is protected by U.S. patents and other intellectual property rights. Use of this copyright protection technology must be authorized by Macrovision, and is intended for home and other limited viewing uses only unless otherwise authorized by Macrovision. Reverse engineering or disassembly is prohibited.

Symbols Used in This Manual

The following symbols appear in some headings in this manual.

 **VHS** : Description refers to video cassette tapes.

 **DVD** : Description refers to DVD-Video.

 **CD** : Description refers to Audio CD.

Note to CATV system installer

This reminder is provided to call the CATV system installer's attention to Article 820-40 of the NEC that provides guidelines for proper grounding and, in particular, specifies that the cable ground should be connected to the grounding system of the building, as close to the point of cable entry as practical.

Maintenance

Servicing

- Please refer to relevant topics on the "Troubleshooting Guide" on page 23 before returning the product.
- If this unit becomes inoperative, do not try to correct the problem by yourself. There are no user-serviceable parts inside. Turn off, unplug the power plug, and please call our toll free customer support line found on the cover of this manual to locate an authorized service center.

Cleaning the Cabinet

- Wipe the front panel and other exterior surfaces of the unit with a soft cloth.
- Never use a solvent, thinner, benzene or alcohol to clean the unit. Do not spray insecticide liquid near the unit. Such chemicals may discolor the surface or damage the unit.

Cleaning Discs

- When a disc becomes dirty, clean it with a cleaning cloth. Wipe the disc from the center to out. Do not wipe in a circular motion.
- Do not use solvents such as benzine, thinner, commercially available cleaners, detergent, abrasive cleaning agents or antistatic spray intended for analog records.

Cleaning the Disc Lens

- If this unit continues to perform improperly even after you have referred to the relevant sections and to the "Troubleshooting Guide" in this manual, the laser optical pickup unit may be dirty. Consult your dealer or an authorized service center for inspection and cleaning of the laser optical pickup unit.

Disc Handling

- When you handle a disc, hold it by its edge and try not to touch the surface of the disc.
- Always store the disc in its protective case when not in use.

Auto Head Cleaning

- Automatically cleans video heads as you insert or remove a cassette tape, so you can see a clear picture.
- Playback picture may become blurred or interrupted while the TV program reception is clear. Dirt accumulated on the video heads after a long period of use, or the usage of rental or worn cassette tapes can cause this problem. If a streaky or snowy picture appears during playback, the video heads in your unit may need to be cleaned.

1. Please visit your local audio/video store and purchase a good quality VHS video head cleaner.
2. If a Video head cleaner does not solve the problem, please call our toll free customer support line found on the cover of this manual to locate an authorized service center.

Hint

- Remember to read the instructions along with the video head cleaner before use.
- Clean video heads only when problems occur.

© 2009 Funai Electric Co., Ltd.

All rights reserved. No part of this manual may be reproduced, copied, transmitted, disseminated, transcribed, downloaded or stored in any storage medium, in any form or for any purpose without the express prior written consent of Funai. Furthermore, any unauthorized commercial distribution of this manual or any revision hereto is strictly prohibited.

Information in this document is subject to change without notice. Funai reserves the right to change the content herein without the obligation to notify any person or organization of such changes.

FUNAI with the  design is a registered trademark of Funai Electric Co., Ltd. and may not be used in any way without the express written consent of Funai. All other trademarks used herein remain the exclusive property of their respective owners. Nothing contained in this manual should be construed as granting, by implication or otherwise, any license or right to use any of the trademarks displayed herein. Misuse of any trademarks or any other content in this manual is strictly prohibited. Funai shall aggressively enforce its intellectual property rights to the fullest extent of the law.

Manufactured under license from Dolby Laboratories. "Dolby" and the double-D symbol are trademarks of Dolby Laboratories.

About the Video Cassettes and Discs

Playable Video Cassettes

Use only cassettes marked **VHS** with this unit.

Playable Discs

Playable discs	Mark (logo)	Region code	Recorded signals	Disc size	Disc types
DVD-Video *1, 2, 4, 6, 10			Digital video (MPEG2)	12 cm or 8 cm	
DVD-RW DVD-R *1, 3, 4, 5, 6, 7, 8, 9, 10		—			
DVD+RW DVD+R *1, 3, 4, 5, 6, 8, 9, 10		—			
Audio CD *4, 6, 10		—	Digital audio	12 cm or 8 cm	
CD-RW CD-R *4, 5, 6, 9, 10		—	Digital audio		

DVD is a trademark of DVD Format/Logo Licensing Corporation.

If you cannot play back a disc which bears one of the marks above, check the following notes.

- *1: This unit conforms to the NTSC color system. Discs recorded in other color systems such as PAL cannot be played back.
- *2: Certain DVD-Video discs do not operate as described in this manual due to the intentions of the disc's producers.
- *3: Discs Recorded in the VR (Video Recording) format cannot be played back.
- *4: Scratched or stained discs may not be played back.
- *5: Some discs cannot be played back because of incompatible recording conditions, characteristics of the recorder or special properties of discs.
- *6: You can play back discs which bear the marks above. If you use non-standardized discs, this unit may not play them back. Even if they are played back, the sound or video quality will be compromised.
- *7: You may play back the unfinalized DVD-R/RW disc recorded in the video format on our brand's DVD recorder. However, depending on the recording status of a disc, the disc may not be played back at all or normally (the picture or sound may not be smooth, etc.). In this case, you need to finalize the disc with the DVD recorder. Refer to the manual accompanying the DVD recorder.
- *8: Only the discs recorded in the video format and finalized can be played back. Unfinalized discs cannot be played back. Depending on the recording status of a disc, the disc may not be played back at all. (the picture or sound may not be smooth, etc.)
- *9: If the recorded portion of the disc is too small (less than 2 3/16 inches (55 mm) across), it may not play back properly.
- *10: Do not glue paper or put stickers on to the disc. These may damage the disc, and the unit may not read it correctly.

Unplayable Discs

NEVER play back the following discs. Otherwise, malfunction may result!

DVD-RAM / DVD-Audio / CD-i / Photo CD / Video CD / DVD with region codes other than 1 or ALL / DTS-CD / DVD-ROM for personal computers / CD-ROM for personal computers

On the following disc, the sound MAY NOT be heard.

Super Audio CD

NOTE: Only the sound recorded on the normal CD layer can be delivered.

The sound recorded on the high density Super Audio CD layer cannot be delivered.

Any other discs without compatibility indications

Setup

Connections

Please refer to "Basic TV Connection" on the front page before you use this unit.

RF Output Channel

If channel 3 has been already occupied for broadcasting,

- 1) Set your TV to channel 4.
- 2) Insert a pre-recorded tape into this unit.
- 3) Press **[SOURCE]** on the unit so that the VCR SOURCE light is lit.
 - If noise appears on the TV screen, press **[VCR/TV]** on the remote control.
- 4) Press **[PLAY ▶]** once.

- 5) After a few seconds, press and hold **[PLAY ▶]** on the unit for 3 seconds.
 - The RF output channel will change to channel 4 from channel 3 and you will see a playback picture.
 - When a picture does not appear on the TV screen, repeat step 4.
- 6) Press **[STOP ■]** to stop playback.

Hint

- The RF output channel does not change when you adjust tracking during playback. In case RF output channel changes, you can easily switch it back. Start the playback again then press and hold **[PLAY ▶]** on the unit for 3 seconds.

Hint for Cable Box or Satellite Box

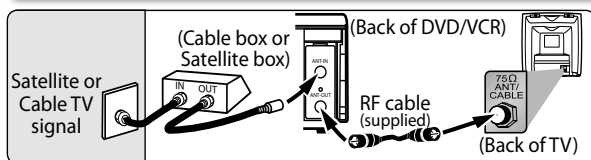

Select this connection when you want to view or record a scrambled channel. With this connection, channels cannot be changed on the unit. You can view or record **ONLY** the channels you have selected on the cable box or the satellite box.

- While you are recording, only the recorded channel can be viewed.

To select channels of the cable box or satellite box

- 1) Turn on the unit by pressing **[STANDBY-ON]**, then press **[VCR/TV]**. The STANDBY-ON indicator on the front panel will light, then press **[SKIP/CH. ▶▶/▲, ◀◀/▼]** to select channel 3 or 4 (the same channel as the output channel of the cable box or satellite box).
 - If you use the channel 4, you need to change the unit's RF output to channel 4. Refer to "RF Output Channel".
- 2) At the TV, select channel 3 or 4 (the same channel as you have selected at step 1).
- 3) On the cable box or satellite box, select the channel you want to view or record.

Connection to an Audio System

Method 1

Stereo system

Audio Analog audio input jacks

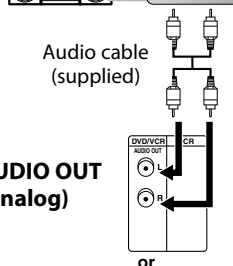

AUDIO OUT (Analog)

DVD/VCR

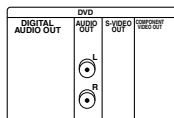

(DVD mode only)

Method 2

Dolby Digital decoder, MD deck or DAT deck

Digital audio input jack

Audio Coaxial Digital cable (commercially available)

DIGITAL AUDIO OUT

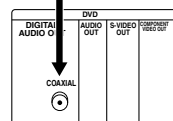

Connection	Setting	SETUP > AUDIO > DOLBY DIGITAL
Connecting to a Dolby Digital decoder for Dolby Digital audio output.		BITSTREAM
Connecting to other equipment (an MD deck or DAT deck etc.) without Dolby Digital decoder.		PCM

* To complete these settings, refer to pages 20-21.

Hint

- The audio source on a disc in a Dolby Digital Multi channel surround format cannot be recorded as digital sound by an MD or DAT deck.
- By hooking this unit up to a Multi channel Dolby Digital decoder, you can enjoy high-quality Dolby Digital Multi channel surround sound as heard in the movie theaters.
- Playing a DVD using incorrect settings may generate noise distortion and may also damage the speakers.

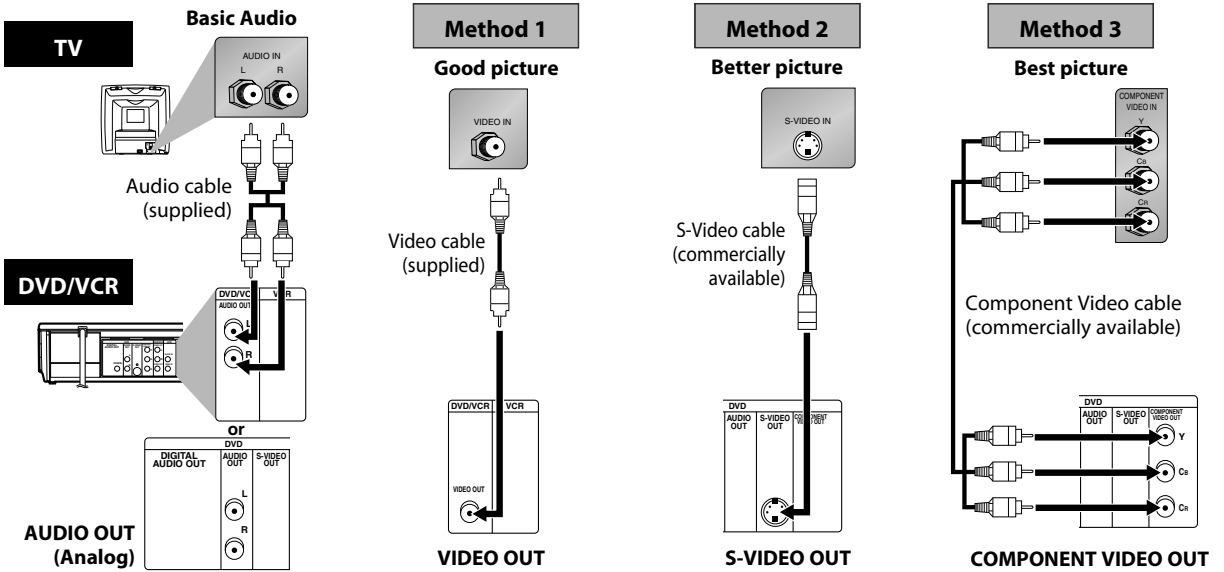

Hint

- Connect this unit directly to the TV. If the Audio/Video cables are connected to a VCR, pictures may be distorted due to the copy protection system.
- The COAXIAL, DVD AUDIO OUT, S-VIDEO OUT and COMPONENT VIDEO OUT jacks are only useful in DVD mode.

After you have completed connections

Press the input selector button (usually TV/VIDEO, INPUT or AUX) on your TV to switch an appropriate external input channel (usually near channel 0) for viewing the picture from this unit. If the picture does not appear, also refer to the manual accompanying your TV.

INPUT MODES FOR COMMON TV BRANDS

Listed below are inputs for common brand name TV's.

Admiral:	AUX	Panasonic:	TV/VIDEO
Curtis Mathis:	LINE1, LINE2, 00, 90, 91, 92, 93	RCA:	INPUT, TV/VCR, 00, 90, 91, 92, 93
GE:	INPUT, TV/VCR, 00, 90, 91, 92, 93	Samsung:	TV/VIDEO
Hitachi:	INPUT, AUX	Sanyo:	VIDEO
JVC:	VIDEO, VIDEO1, VIDEO2, VIDEO3	Sharp:	00
Kenwood:	AUX	Sony:	VIDEO1, VIDEO2, VIDEO3
LXI-Series:	00	Toshiba:	TV/GAME
Magnavox:	AUX CHANNEL	Zenith:	00

Preparation for Use

Turn on the Unit for the First Time



Operations described in this manual are mainly based on the remote control.

- Turn on the TV and set it to channel 3.
 - If channel 3 has been already occupied for broadcasting, see "RF Output Channel" section on page 6.



- Select your language when turning this unit on for the first time. Then press **[▶]** to go to next step.

STANDBY-ON

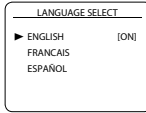
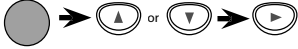

- Press **[▶]** to start Auto Set Up.

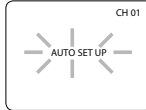

Do you connect the cable from the cable box or the satellite box to the unit's ANT-IN jack?



Yes Press **[MENU]** to exit.
• Refer to "Hint for Cable Box or Satellite Box" section on page 6.

No Please wait for a few minutes. After scanning...
• The tuner stops on the lowest memorized channel.
• You can select only the channels memorized in this unit by using **[SKIP/CH.▶▶/▲, ◀◀/▼]** (or **[CHANNEL ▲/▼]**).
• If "AUTO SET UP" appears on the TV screen again, check the cable connections. Then, press **[▶]** once again.

Hint

• Repeat these steps only if either there was a power failure or this unit has been unplugged for more than 30 seconds.

To Select a Channel

You can select a channel by using the **number buttons** or **[SKIP/CH.▶▶/▲, ◀◀/▼]**.

Notes for using the number buttons:

- When selecting cable channels which are higher than 99, enter channel numbers as a three-digit number. (for example: 117, press **[1], [1], [7]**)
- You must precede single-digit channel numbers with a zero. (for example: 02, 03, 04 and so on)

To Add or Delete Channels



- Press **[MENU]** to select "CHANNEL SET UP". Then press **[▶]** to go to next step.

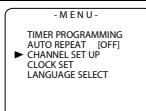
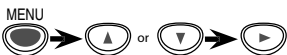

• If the clock is not set, the "CLOCK SET" screen appears when you press **[MENU]**. In this case, press **[MENU]** again.

- Select "MANUAL SET UP". Then press **[▶]** to go to next step.

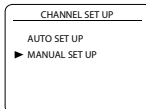

- Select the channel to be added or deleted.

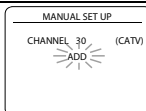
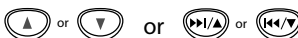

- Select "ADD" or "DELETE".

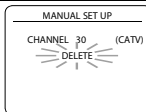
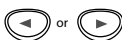

- To exit the menu



To Preset the Channel Again

- Press **[MENU]** until the main menu appears.
- Select "CHANNEL SET UP" by using **[▲/▼]**, then press **[▶]**.
- Select "AUTO SET UP" by using **[▲/▼]**, then press **[▶]**. After scanning, the tuner stops on the lowest memorized channel.

To Change the On-Screen Language

- Press **[MENU]** until the main menu appears.
- Select "LANGUAGE SELECT" by using **[▲/▼]**, then press **[▶]**.
- Select "ENGLISH", "FRANCAIS" or "ESPAÑOL" by using **[▲/▼]** then press **[CLEAR/C.RESET]**.

Hint

- If you accidentally select Spanish or French and need English: Press **[MENU]** and choose SELEC. IDIOMA or SELECTION LANGUE. Press **[▶]** and select ENGLISH. Finally, press **[CLEAR/C.RESET]**.
- To add or delete channels in this unit, **[SKIP/CH.▶▶/▲, ◀◀/▼]** button works on the channel number memorized in this unit, **[▲/▼]** works on all.

Clock Setup



- Press **[MENU]** and select "CLOCK SET". Then press **[▶]** to go to next step.

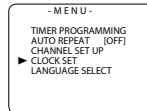

• If the clock is not set, the CLOCK SET screen appears when you press **[MENU]**. In this case, go to step 2.

- Select the current month. Then press **[▶]** to go to next step.

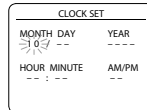

- Select the current day. Then press **[▶]** to go to next step.

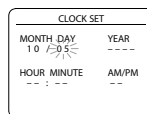

- Select the current year. Then press **[▶]** to go to next step.

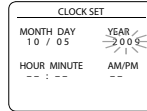

- Select the current hour. Then press **[▶]** to go to next step.

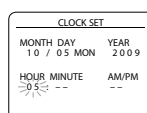

- Select the current minute. Then press **[▶]** to go to next step.

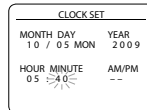

- Select "AM" or "PM".

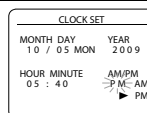
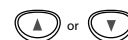

- To exit the CLOCK SET screen



Hint

- To go back one step, press **[◀]** (during steps 2 to 7).
- Your clock setting will be lost if either there is a power failure or this unit has been unplugged for more than 30 seconds.

Function Overview

Front Panel Indicator

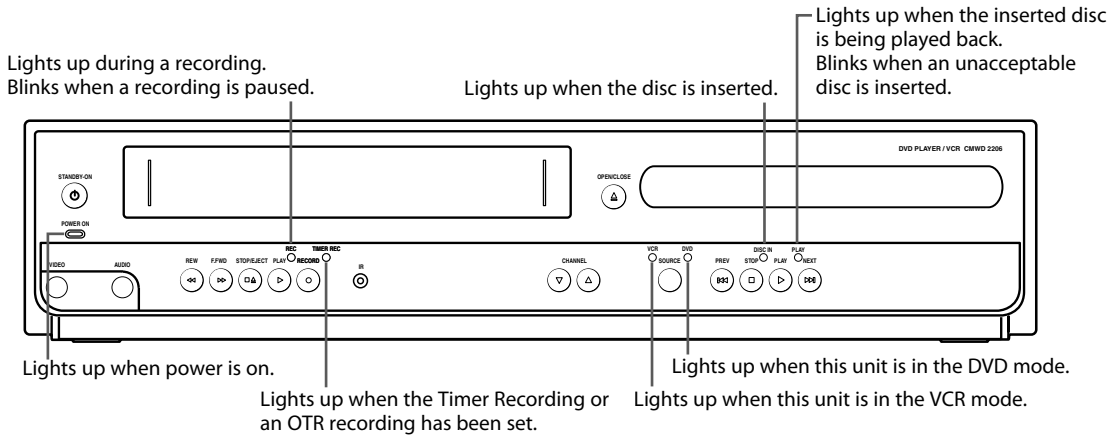

VCR / DVD Switching

You must first select which component you wish to operate with [**SOURCE**], as this product is a combination of a VCR and a DVD player.

VCR MODE

Press [**VCR**] on the remote control.
(Verify that the VCR SOURCE light is lit.)

DVD MODE

Press [**DVD**] on the remote control.
(Verify that the DVD SOURCE light is lit.)

Hint

• Pressing only [**SOURCE**] on the front panel DOES NOT switch the mode of the remote control. You MUST select the correct mode on the remote control.

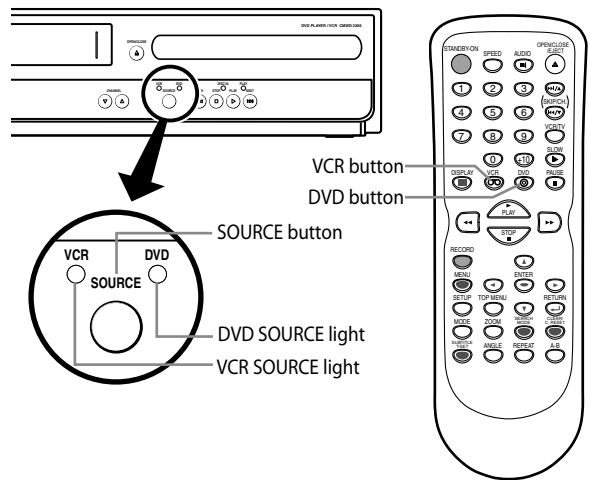

Front & Rear Terminals

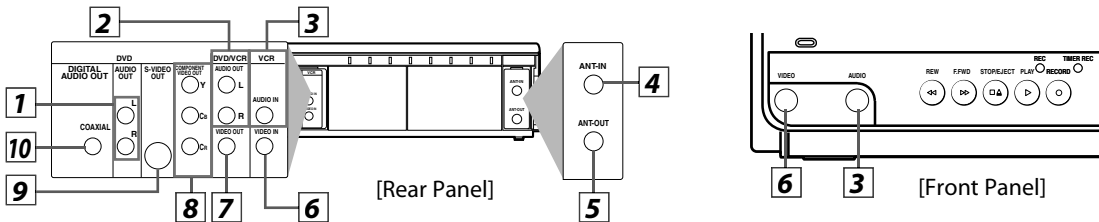

1: DVD AUDIO OUT (analog) jacks

Connect the supplied audio cable here through the audio in jacks of a television or other audio equipment. (DVD only)

2: DVD/VCR AUDIO OUT jacks

Connect the supplied audio cable here through the audio in jacks of a television or other audio equipment.

3: AUDIO IN jack

Connect audio cable coming from the audio out jack of a camcorder, another VCR or an audio source here.

4: ANT-IN jack

Connect your antenna or cable box here.

5: ANT-OUT jack

Connect the supplied RF cable to the antenna input jack of a television.

6: VIDEO IN jack

Connect a cable coming from the video out jack of a camcorder, another VCR or an audio-visual source (laser disc player, video disc player, etc.) here.

7: DVD/VCR VIDEO OUT jack

Connect the supplied video cable here through the video in jack of a television.

8: COMPONENT VIDEO OUT jacks

Connect optional COMPONENT VIDEO cables here through the COMPONENT VIDEO in jacks of a television. (DVD only)

9: S-VIDEO OUT jack

Connect an optional S-VIDEO cable here through the S-VIDEO in jack of a television. (DVD only)

10: DIGITAL AUDIO OUT COAXIAL jack

Connect an optional coaxial digital audio cable here through the coaxial digital audio in jack of a decoder or audio receiver. (DVD only)

Remote Control

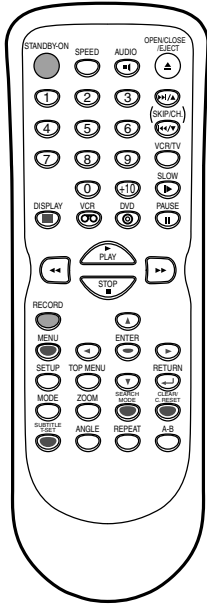

Installing the Batteries for the Remote Control

Install two AA (1.5V) batteries (supplied) matching the polarity indicated inside battery compartment of the remote control.

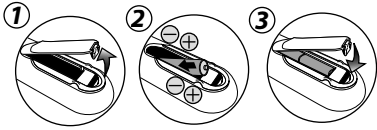

Keep in mind the following when using the remote control:

- Make sure that there is no obstacle between the remote control and the remote sensor on the unit.
- The maximum operable ranges from the unit are as follows.
 - **Line of sight:** approx. 23 feet (7m)
 - **Either side of center:** approx. 16 feet (5m) within 30°
 - **Above:** approx. 16 feet (5m) within 15°
 - **Below:** approx. 10 feet (3m) within 30°



Hint

- Do not mix alkaline, standard (carbon-zinc), or rechargeable (ni-cad, ni-mh, etc) batteries.
- Do not mix old and new batteries.
- Always remove batteries from remote control if they are dead or if the remote control is not to be used for an extended period of time. This will prevent battery acid from leaking into the battery compartment.

Button (Alphabetical order)	Disc/Tape	DVD mode		VCR mode
		DVD	CD	VHS
1-9		• To select chapter or title directly.	• To select track directly.	• To select channel. • The +10 button has no effect in VCR mode.
◀ ▶		• To search forward/backward through a disc. • To begin slow forward playback in the pause mode.	• To search forward/backward through a disc.	• To forward/backward a tape.
A-B		• To repeat between your chosen point of A and B.	• To repeat between your chosen point of A and B.	—
ANGLE		• To select camera angles on a disc.	—	—
AUDIO		• To select audio languages on a disc.	• To select STEREO, L-ch or R-ch.	—
CLEAR, C, RESET		• To remove status number in program input. • To clear the numbers entered incorrectly. • To cancel the point for A-B repeat.	• To remove status number in program input. • To clear the numbers entered incorrectly. • To cancel the point for A-B repeat.	• To exit the VCR Menu. • To reset the tape counter.
DISPLAY		• To display the current disc mode.	• To display the current disc mode.	• To display the current time, tape counter, and channel.
DVD		• To select the DVD output mode. • To activate the remote control in DVD mode.	• To select the DVD output mode. • To activate the remote control in DVD mode.	—
◀ ENTER ▶		• To move the cursor and determine its position.	• To move the cursor and determine its position.	• To select an item on the VCR Menu. • To advance to the next VCR Menu. • To go back one step during clock and timer setting.
MENU		• To call up the Menu on a disc.	—	• To call up the VCR Menu.
MODE		• To arrange the playing order or play randomly. • To set black level on/off. • To set virtual surround on/off.	• To arrange the playing order or play randomly. • To set virtual surround on/off.	—
OPEN/CLOSE EJECT		• To open or close the disc tray.	• To open or close the disc tray.	• To eject the video cassette from the VCR.
PAUSE		• To pause disc playback. • To advance playback one frame at a time.	• To pause disc playback.	• To pause tape playback or recording. • To advance playback one frame at a time.
▶ PLAY		• To begin disc playback.	• To begin disc playback.	• To begin tape playback.
RECORD		—	—	• To start a recording or One Touch Recording.
REPEAT		• To play a chapter or title repeatedly.	• To play a track or disc repeatedly.	—
RETURN		• To return to the previous operation in menu.	• To return to the previous operation in menu.	—
SEARCH MODE		• To search chapter, title or time. • To set or search the markers.	• To search track. • To search time. • To set or search the markers.	• To call up the index or time search menu.
SETUP		• To call up the DVD setup menu.	• To call up the DVD setup menu.	—
SKIPCH SKIPICHL M/A N/V		• To skip chapters or titles.	• To skip tracks.	• To change channels. • To adjust the tracking manually during playback.
SLOW		—	—	• To view the tape in slow motion.
SPEED		—	—	• To select the recording speed.
STANDBY/ON		• To turn the unit on or to turn the unit into the standby mode. (To completely turn off the unit, you must unplug the AC power cord.)	• To turn the unit on or to turn the unit into the standby mode. (To completely turn off the unit, you must unplug the AC power cord.)	• To turn the unit on or to turn the unit into the standby mode. (To completely turn off the unit, you must unplug the AC power cord.)
STOP		• To stop playback.	• To stop playback.	• To stop playback or recording.
SUBTITLE T-SET		• To select subtitles on a disc.	—	• To put the VCR into standby mode for a Timer Recording.
TOP MENU		• To call up the Top Menu on a disc.	—	—
VCR		—	—	• To select the VCR output mode. • To activate the remote control in VCR mode.
VCR TV		• To select DVD position or TV position.	• To select CD position or TV position.	• To select VCR position or TV position.
ZOOM		• To magnify part of a picture. (x2 / x4)	—	—

VCR Functions

Playback

Before:

Turn on the TV and set it to channel 3.

• If channel 3 has been already occupied for broadcasting, see "RF Output Channel" section on page 6.



<p>1 Insert a video cassette into this unit.</p>	<p>2 To start playback</p>
<p>3 To stop playback</p>	<p>4 To eject the cassette</p>

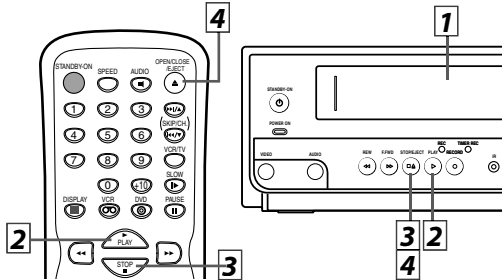

Hint

- When a tape without record tab is inserted, the unit will start playback automatically.
 - Tracking will be automatically adjusted upon playback.
- To adjust the tracking manually, press [SKIP/CH. >>>|▲, <<<|▼] (or [CHANNEL ▲/▼]) during playback.

Other Operations

To cue or review picture during playback (Picture Search)

Use [▶▶] or [◀◀] ([F.FWD ▶▶] or [REW ◀◀]).

• Press it again and the unit will search in super high speed. (in the SLP mode only)

To freeze the picture on TV screen during playback (Still mode)

Press [PAUSE II]. Each time you press the button, the picture will be forwarded by one frame.

• If the picture begins to vibrate vertically in the still mode, stabilize the picture by using [SKIP/CH. >>>|▲, <<<|▼] (or [CHANNEL ▲/▼]).

• If the picture is distorted or rolling vertically, adjust the vertical hold control on your TV if equipped.

Counter Reset

Press [CLEAR/C.RESET].

To play back in slow motion (Slow mode)

Press [SLOW] during playback or the still mode.

• If the noise bars appear on the TV screen, you can reduce it by using [SKIP/CH. >>>|▲, <<<|▼] (or [CHANNEL ▲/▼]).

Auto Rewind

When a tape reaches its end during playback, fast-forward or recording (except Timer Recording and One Touch Recording), the tape will automatically rewind to the beginning. After rewinding finishes, the unit will eject the tape.

Hint

- Still/Slow mode will be automatically canceled after 5 minutes to prevent damage to the tape and the video head.
- To return to playback from the Picture Search/Still/Slow mode, press [PLAY ▶].

Index Search

You can skip the program backward and forward by the Index Mark.



• Insert a tape into this unit.

1 Press [SEARCH MODE] once.



2 To select Index Mark

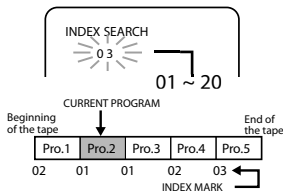

3 To rewind



To fast forward



4 After searching, it automatically starts playback.



Hint

- The Index Mark will be made automatically at the beginning of each recording.
- The time gap between Index Marks should be greater than 1 minute for SP mode, 2 minutes for LP mode and 3 minutes for SLP mode.

Time Search

You can search backward and forward a specific length of time on a tape.



• Insert a tape into this unit.

1 Press [SEARCH MODE] twice.



2 Select the desired length of time for fast forwarding or rewinding.

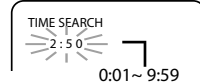

(1 minute~9 hours and 59 minutes)

3 To rewind



To fast forward



4 After searching, it automatically starts playback.



Hint for Index Search & Time Search

- These functions are not available during recording.
- Press [STOP ■] to stop the search.
- If a tape ends during a search, your search will be canceled and the tape will rewind to the beginning.

Auto Repeat

This function will playback a tape repeatedly from the beginning when the tape reaches the end.



- 1 Press [MENU], and choose "AUTO REPEAT" during playback.

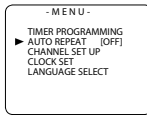
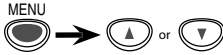

- 2 Press [▶] for "AUTO REPEAT", "ON" or "OFF".

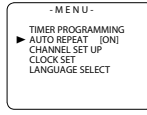

Hint

- To cancel Auto Repeat, follow step 1 above. Then, press [▶] so that "OFF" appears beside "AUTO REPEAT". Press [CLEAR/C.RESET] to exit.
- If menu remains on the TV screen after step 2, press [CLEAR/C.RESET] to exit.
- The Auto Repeat playback will start automatically if you select "AUTO REPEAT" to "ON" in the stop mode.

Recording

Recording & OTR (One Touch Recording)

Before: Turn on the TV and set it to channel 3.

- If channel 3 has been already occupied for broadcasting, see "RF Output Channel" section on page 6.



- 1 Insert a cassette with tab into this unit.



- 2 Select the channel to record.

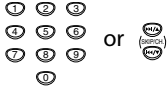

- 3 Press [SPEED] to select the desired tape speed.

SPEED

Type of tape	T60	T120	T160
SP mode	1hour	2hours	2-2/3hours
SLP mode	3hours	6hours	8hours

- 4 Press [RECORD] repeatedly to select the desired recording length.

RECORD

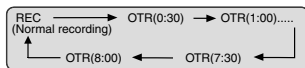

- 5 To stop recording



- 6 To eject the recorded cassette

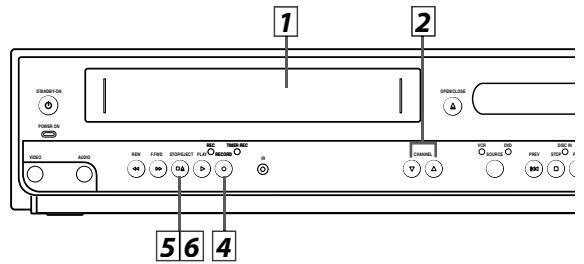
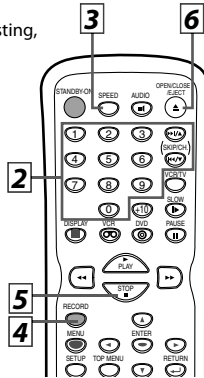

Accidental erasure prevention

To prevent accidental recording on a recorded cassette, remove its record tab. To record on it later, cover the hole with adhesive tape.

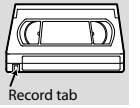

You **CANNOT** dub a DVD to a videotape.

To stop recording temporarily (Pause mode)

Press [PAUSE II].

- During the rec-pause mode, five ■ marks appear on the TV screen. Each ■ mark represents one minute.
- Press it again to resume recording.
- Pause mode will be automatically canceled after 5 minutes to prevent damage to the tape and the video head.

Hint

- If you want to watch one channel while recording another...
 - 1) If noise appears on the TV screen, press [VCR/TV] to put the unit in TV position.
 - 2) You cannot record one channel while watching another if you have a cable box or satellite receiver.

Timer Recording



• Insert a tape with its record tab into the unit.

- 1 Press [MENU], then select "TIMER PROGRAMMING".

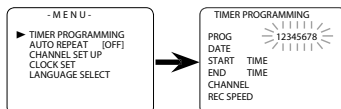
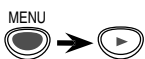

Available program number flashes.

- 2 Select an empty program number. Then press [▶] to go to next step.

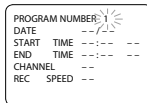

- 3 Select "ONCE", "DAILY" (Mon-Fri), or "WEEKLY". Then press [▶] to go to next step.

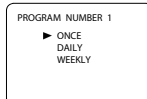

- 4 Select the desired date. Then press [▶] to go to next step.

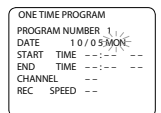
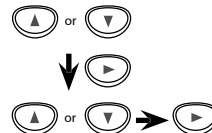

- You can set a program one year in advance.

- 5 Select the desired start time (hour). Then press [▶] to go to next step.

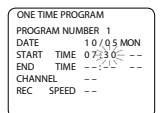
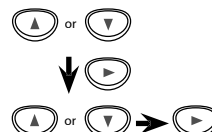

- 6 Select "AM" or "PM".
Then press **[▶]** to go to next step.

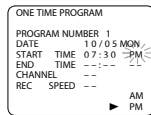

- 7 Repeat the procedure in steps 5 and 6 to set the end time.



- 8 Select the desired channel.
Then press **[▶]** to go to next step.

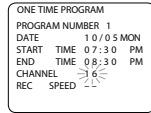

- If you have connected the unit to a cable box or satellite box as the connection on page 6, select the VCR to channel 3 or 4 (the RF output channel of the VCR). Then, select the desired channel at the cable box or satellite box. Leave the cable box or satellite box on for Timer Recording.

- 9 Select the desired recording speed, then press **[CLEAR/C.RESET]**.

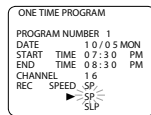
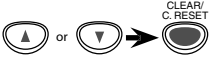

- To set another program after step 9, press **[▶]**. Then, continue with step 2.

- 10 Press **[SUBTITLE/T-SET]** to set timer standby mode.



- TIMER indicator on the front panel lights up. The unit will change to the DVD mode.

Hint

- To go back one step, press **[◀]** during steps 3 to 9.

To Check, Correct or Cancel a Timer Program

- 1) Press **[SUBTITLE/T-SET]** then, **[VCR]** on the remote control.
- 2) Select main menu by pressing **[MENU]**.
- 3) Select "TIMER PROGRAMMING" by using **[▲/▼]**, then press **[▶]**.
- 4) Select the program number which you want to check by using **[▲/▼]**. The details of the program you selected will appear on the TV screen.
 - Go to the digit you want to change by using **[◀/▶]**. Then, enter correct numbers by using **[▲/▼]**.
 - You may cancel the entire program by pressing **[◀]** while the program number blinks.
- 5) Press **[CLEAR/C.RESET]** to exit.
- 6) Press **[SUBTITLE/T-SET]** to return to timer standby mode.

To cancel a Timer Recording in progress

Press **[STOP/EJECT ■ ▲]** on the unit.

Hints for OTR and Timer Recording

- Press **[VCR]** on the remote control before you set Timer Recording. Make sure the remote control is in the VCR mode, then press **[SUBTITLE/T-SET]**.
- If a tape is not in the unit or does not have the record tab, TIMER indicator on the front panel blinks and Timer Recording cannot be performed. Please insert a recordable tape.
- When Timer Recordings are set, TIMER indicator on the front panel lights up. To use the VCR as usual until the time for the recording, press **[SUBTITLE/T-SET]** so that TIMER indicator light turns off. Press **[VCR/TV]** to choose the VCR position. Select either VCR or DVD mode, then continue with the other features as described in this manual.

After an OTR or a Timer Recording has been set, this unit operates as follows:

- If a tape runs out before an OTR or a Timer Recording is finished, the unit ejects the tape. Press **[SUBTITLE/T-SET]** on the remote control or **[STOP/EJECT ■ ▲]** on the unit, then press **[VCR]** to activate the VCR function again.
- Once the unit turns to the timer standby mode, no VCR functions are available until **[SUBTITLE/T-SET]** is pressed.
- To cancel the timer standby mode, press **[SUBTITLE/T-SET]** on the remote control or **[STOP/EJECT ■ ▲]** on the unit, then press **[VCR]** to activate the VCR function again.
- The mode of the unit and the remote control may differ (VCR mode or DVD mode) when you set Timer Recording or after you canceled Timer Recording. Press **[VCR]** or **[DVD]** on the remote control to select your desired mode before you operate.

When an OTR or a Timer Recording is completed...

- If Auto Power Off for DVD has been activated and there are Timer Recordings on standby, the unit turns off automatically, and TIMER indicator on the front panel lights to indicate the unit is in the timer standby mode.
- TIMER indicator on the front panel flashes if there are no more Timer Recordings on standby.
- If Auto Power Off for DVD has NOT been activated, the unit switches to the DVD mode and all the VCR functions will be unavailable. All the DVD functions are available during OTR, timer standby mode and Timer Recording.
- Press **[STOP/EJECT ■ ▲]** on the front panel or **[SUBTITLE/T-SET]** on the remote control to use the VCR when the unit is off.
- Press **[SOURCE]** on the front panel or **[VCR]** on the remote control to use the VCR when the unit is on. In case Timer Recording is in standby mode, press **[STOP/EJECT ■ ▲]** on the front panel or **[SUBTITLE/T-SET]** on the remote control, and then press **[SOURCE]** on the front panel or **[VCR]** on the remote control.

If you want to use the DVD player during a Timer Recording or while TIMER indicator on the front panel is on or blinking.

- Press **[STANDBY-ON]** to turn on the unit. Press **[DVD]** on the remote control to choose DVD mode, then continue with the other DVD features as described in this manual.

NOTE (for Timer Recording) :

- If there is a power failure or the unit is unplugged for more than 30 seconds, clock and all timer settings will be lost.

Copying a Video Tape

Warning: Unauthorized recordings of copyrighted video tapes may be an infringement of copyright laws.

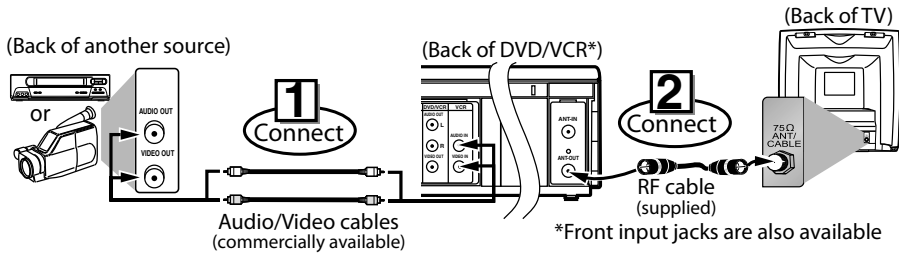

- 1) Insert a pre-recorded tape into another VCR for playing.
- 2) Insert a tape with its record tab into this unit for recording.
- 3) Press **[SPEED]** on the remote control of the recording unit to select the desired recording speed (SP/SLP).
- 4) Select the "L1" or "L2" position on the recording unit.
 - To use the input jacks on the back of this unit, select "L1" position by pressing **[0], [0], [1]** on the remote control or **[CHANNEL ▲/▼]** on this unit.
 - To use the input jacks on the front of this unit, select "L2" position by pressing **[0], [0], [2]** on the remote control or **[CHANNEL ▲/▼]** on this unit.
- 5) Press **[RECORD]** on the recording unit.
- 6) Begin playback of the tape in another source.
- 7) To stop recording, press **[STOP/EJECT ■ ▲]** on the recording unit, then stop playback of the tape in another source.

Hint

- For best results during dubbing, use the front panel controls whenever possible. The remote control might affect another source's operation.
- Always use video-quality shielded cables with RCA-type connectors. Standard audio cables are not recommended.
- You can use a video disc player, satellite receiver or other audio/video component with Audio / Video outputs.
- "L1" or "L2" is found below the lowest memorized channel. (Example: CH02)
- "L2" input jacks are on the front of this unit.

DVD Functions

Operations described in this section are mainly based on the remote control use. Some operations can be carried out on main unit.

Playback

Before: Turn on the TV, amplifier and any other equipment which are connected to this unit. Make sure the TV and audio receiver (commercially available) are set to the correct channel.

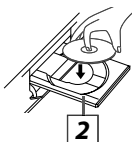

- 1 Press **[STANDBY-ON]** to turn on the DVD/CD Player.
- 2 Press **[OPEN/CLOSE ▲]** and insert a disc with label facing up.
- 3 Press **[PLAY ▶]** to start playback.
- 4 Press **[STOP ■]** to stop playback.

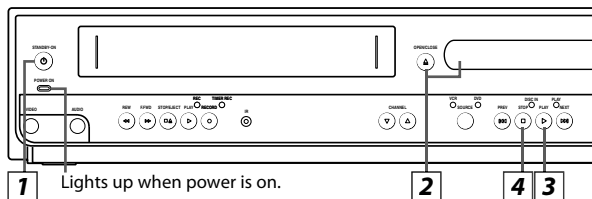
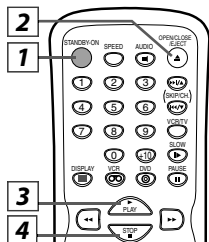

1 Lights up when power is on.

2 4 3

Hint

- A "prohibited icon" may appear at the top-right on the TV screen when the operation is prohibited by the disc or this unit.
- Some DVDs may start playback from title 2 or 3 due to specific programs.
- **During the playback of a two-layered disc, pictures may stop for a moment. This happens while the 1st layer is being switched to the 2nd layer. This is not a malfunction.**

TIP: You can change the On-Screen language in "PLAYER MENU" setting. (Refer to page 20.)

DVD menu



Some discs contain menus which allow you to customize DVD playback. Use **[▲ / ▼ / ◀ / ▶]** to select an item, then press **[ENTER]** (or **[PLAY ▶]**).

Calling Up a Menu Screen during Playback



- Press **[MENU]** to call up the DVD menu.
- Press **[TOP MENU]** to call up the title menu.

Hint

- Menu operations may vary depending on the disc. Refer to the manual accompanying the disc for more details.

Resume



Press **[STOP ■]** during playback. Resume message will appear on the TV screen. Press **[PLAY ▶]**, playback will resume from the point at which playback was stopped.

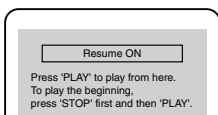

Hint

- To cancel resume, press **[STOP ■]** one more time in the stop mode.
- The resume information will be kept even when unit is in standby mode.

Paused and Step-by-Step Playback



Press **[PAUSE ■]** during playback. To continue playback, press **[PLAY ▶]**.



The disc goes forward by one frame each time **[PAUSE ■]** is pressed in the pause mode. To continue playback, press **[PLAY ▶]**.

Hint

- Set "STILL MODE" to "FIELD" in the DISPLAY menu if pictures in the pause mode are blurred. (Refer to pages 20-21.)

To use **[PREV ◀◀ / ◀◀], [NEXT ▶▶ / ▶▶]** on this unit



Press once to skip chapters or tracks to a desired point. Press and hold to change forward or reverse playback speed.

Fast Forward / Reverse Search



Use **[▶▶]** or **[◀◀]** repeatedly during playback to select the required forward or reverse speed. To continue playback, press **[PLAY ▶]**.

Hint

- For DVDs, fast forward or reverse search speed is different depending on the disc. Approximate speed is 1(x2), 2(x8), 3(x20), 4(x50), 5(x100).
- For Audio CDs, approximate speed is 1(x2), 2(x8), 3(x30).

Slow Forward Reverse



Press **[▶▶]** or **[◀◀]** repeatedly in the pause mode to select the required forward speed. To continue playback, press **[PLAY ▶]**.

Hint

- Slow forward speed is different depending on the disc. Approximate speed is 1(1/16), 2(1/8) and 3(1/2).
- Set "STILL MODE" to "FIELD" in the DISPLAY menu if pictures in the slow playback mode are blurred. (Refer to pages 20-21.)

Zoom



1) Press **[ZOOM]** repeatedly during playback to select the required zoom factor: x2, x4 or OFF.



2) Use **[▲ / ▼ / ◀ / ▶]** to slide the zoomed picture across the screen.
3) To exit zoom function, press **[ZOOM]** repeatedly to select OFF.



Hint

- Zooming function does not work while the disc menu is displayed.
- x4 zoom is not available on some discs.
- The picture may be distorted when you press **[PAUSE ■]** or **[◀◀]** repeatedly in the zoom mode.
- In the zoom mode, it automatically changes **[x2]** (x4) to the zoomed position guide.

Search Functions

SEARCH MODE does not work during Programmed or Random Playback.

Using Track Search

  Operations described in this manual are mainly based on the remote control.

Using [SEARCH MODE]

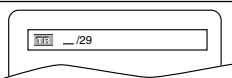
1  

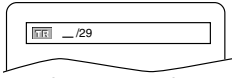
2  
within 30 seconds

- For the disc with less than 10 tracks, press the track number directly.
- For discs with more than 10 but less than 99 tracks, to play singledigit track, press [0] first, then the track number (e.g. for track 3, press [0], [3]). To play a double-digit track, press the track number.
- For discs with more than 100 tracks, to play a single or a double-digit track, press [0] first, then the track number (e.g. for track 3, press [0], [0], [3], and for track 26, press [0], [2], [6]). To play a triple-digit track, press the track number.

Using [SKIP/CH. >>>/<<<] / [▲] / [▼]

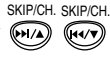
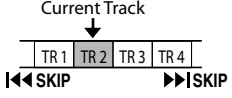
1  →  



Hint

- [+10] can also bring the Track search display, except for the disc with less than 10 tracks. For such a disc, track search can be done by just pressing the track number.

Using Title / Chapter Search





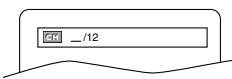

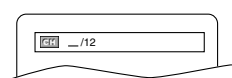
Using [SEARCH MODE]

1 Press [SEARCH MODE] once for the chapter search. Press [SEARCH MODE] twice for the title search.  →  

2  
within 30 seconds

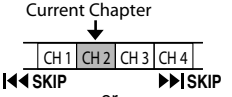
Using [SKIP/CH. >>>/<<<] / [▲] / [▼]

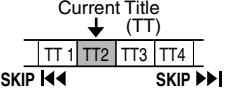

1  →  
or  

Hint

- Depending on the disc being played, this function can also be performed by directly entering the desired chapter number with the **number buttons**. Refer to the manual accompanying the disc.

Using Time Search

1 Press [SEARCH MODE] repeatedly until the Time Search display appears.  →  

2  
within 30 seconds

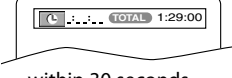
Hint



- When there is no need to enter a number, "0" appears automatically. For example, "0: 0: _ _" appears in the Time Search display if the total time of the title or track is less than 10 minutes.
- Press [CLEAR/C.RESET] to erase the incorrect input at step 2.





Marker Setup

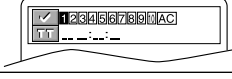

This feature allows you to assign a specific point on a disc to be called back later.

To set a marker

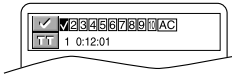

1 Press [SEARCH MODE] repeatedly until the marker display appears.  →  

2    

3  

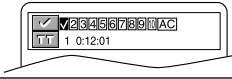
To return to the marker later

1 Press [SEARCH MODE] repeatedly until the marker display appears.  

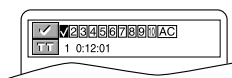
2    

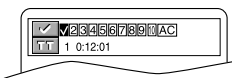
3 Press [ENTER] at the desired marker.  

To exit the marker screen

1 Press [RETURN]. 

Hint

- The Marker display will disappear in about 30 seconds when there is no output.
- To clear a marker, select the marker to be cleared at step 2 in the section "To set a marker" or "To return to the marker later" and then press [CLEAR/C.RESET].
- Opening the disc tray or turning off the power will erase all markers.
- Selecting "AC" at step 2 in the section "To set a marker" or "To return to the marker later" will also erase all markers.

On-Screen Display

You can check the information about the current disc by pressing **[DISPLAY]** on the remote control.

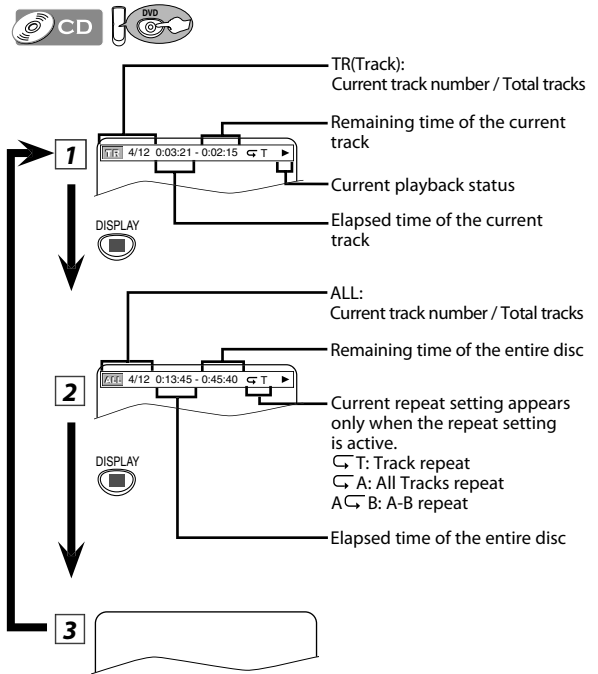
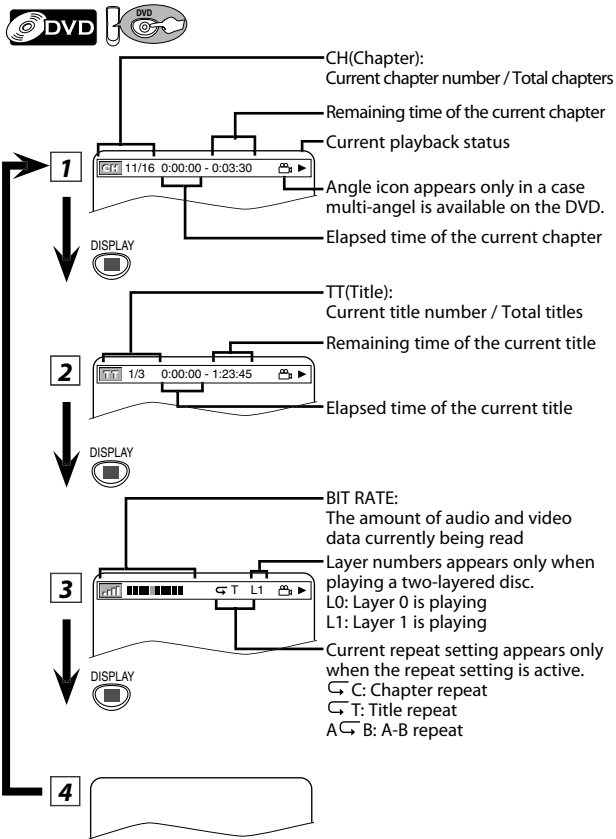

Hint

- When you are playing a disc in PROGRAM or RANDOM mode, **TR** PROGRAM (or RANDOM) will be displayed instead of **2**.

Repeat / Random / Programmed Playback

Repeat Playback



Repeat function is available only during playback.

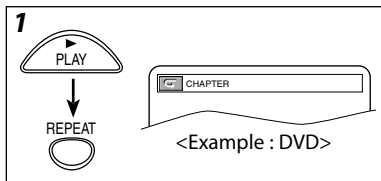

Each time you press [REPEAT], repeat function changes as example below.

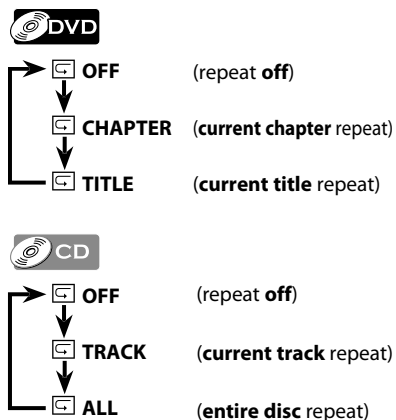

Hint

- Repeat setting (except "ALL") will be cleared when moving to another title, chapter or track.
- Repeat playback may not function with some discs or during repeat A-B playback.

Repeat A-B Playback

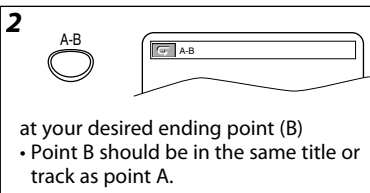
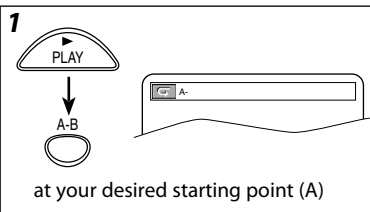

Hint

- To exit the sequence, press [A-B] so that OFF appears.
- To cancel Point A, press [CLEAR/C.RESET] at step 1.
- This function does not work in the other repeat modes.

Random Playback



This function shuffles the playing order of chapters or tracks instead of playback in sequence.

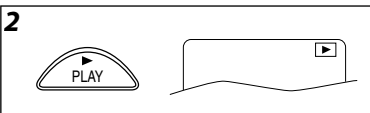
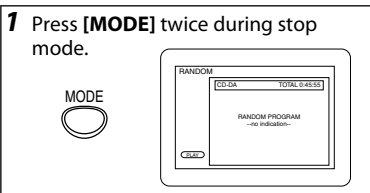

Hint

- To repeat the current track in the random selections, press [REPEAT] repeatedly until "TRACK" appears during playback.
- To repeat the entire random selections, press [REPEAT] repeatedly until "ALL" appears during playback.
- During random playback, you cannot go back to the previous track.

Programmed Playback



You may determine the order in which chapters or tracks will play.

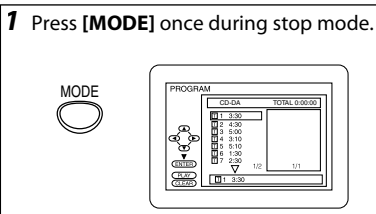

2 Use [▲ / ▼] to select desired track. Press [ENTER].

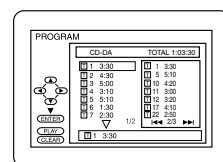

- Up to 99 tracks can be ordered.
- If eight or more tracks were in a program, use [SKIP/CH. ▶▶/▲, ◀◀/▼] to see all the tracks.

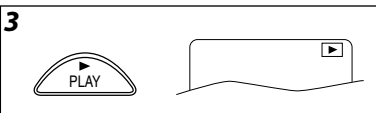

Hint

- Press [CLEAR/C.RESET] at step 2 to erase the most recently entered track.
- To erase all programs at once, select "ALL CLEAR" and press [ENTER] at step 2.
- While a program is being played back, [STOP ■] works as follows;
 - ⇒ Press [STOP ■] and [PLAY ▶] next, so that the programmed playback restarts. (CD playback restarts from the current point.)
 - ⇒ Press [STOP ■] twice and [PLAY ▶] next, so that playback restarts from the first track in the original order. However, your programmed playback can be restarted when you follow the above steps. (Your programs are still stored until either the disc is removed or the power is turned off.)
- To repeat the current track in the program, press [REPEAT] repeatedly until "TRACK" appears during playback.
- To repeat the entire program, press [REPEAT] repeatedly until "ALL" appears during playback.

Special Settings

Subtitle Language



This unit allows you to select a subtitle language (if available) during DVD playback.

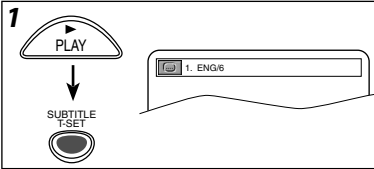

Each time you press [SUBTITLE/T-SET], subtitle language changes as example below.

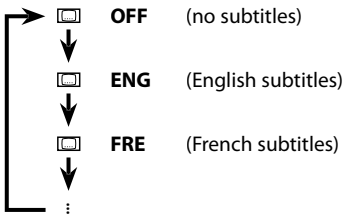

To set subtitle ON/OFF

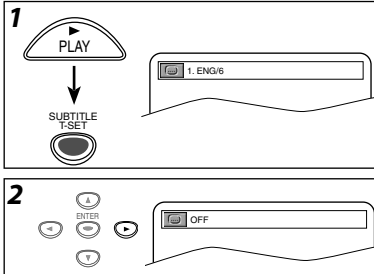

Hint

- If your language is not shown after pressing [SUBTITLE/T-SET] several times, the disc may not have that language. However, some discs have the subtitle language setting on the disc menu. (Operation varies depending on the disc, so refer to the manual along with the disc.)
- When "NOT AVAILABLE" appears on the TV screen, it means no subtitle is recorded on the scene.
- If you choose a language that has a three-letter-language code, the code will be displayed every time you change the subtitle language setting. If you choose any other languages, '---' will be displayed instead. (Refer to page 24.)
- Some discs will only allow you to change the subtitle from the disc menu. Refer to the manual accompanying the discs for details.

Audio Language



This unit allows you to select an audio language (if multiple languages are available on disc) during DVD playback.

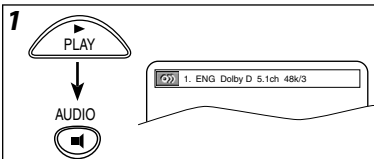

Each time you press [AUDIO], the audio language changes as example below.

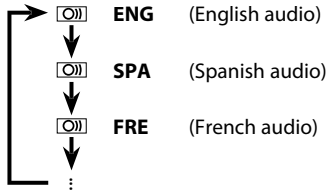

Hint

- Some discs will only allow you to change the audio setting from the disc menu. Refer to the manual accompanying the discs for details.
- When "OFF" appears on the TV screen, it means audio language is not available.
- If your language is not shown after pressing [AUDIO] several times, the disc may not have that language. However, some disc allow audio language setting on the disc menu. (Operation varies depending on the disc, so refer to the manual along with the disc.)

Camera Angles



Some DVD discs may contain scenes which have been shot simultaneously from various angles. You can change the camera angle if the icon appears on the screen. If the "ANGLE ICON" setting is "OFF" in the OTHERS menu, the icon will not appear. (Refer to pages 20-22.)

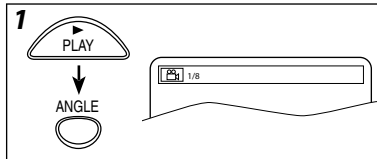

Black Level Setting



Adjust the Black Level Setting to make the dark areas of the TV picture brighter.

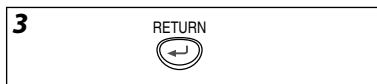
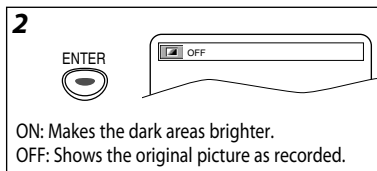
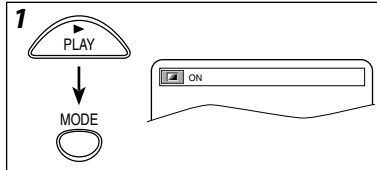

Stereo Sound Mode



This unit allows you to select a sound mode during CD playback.

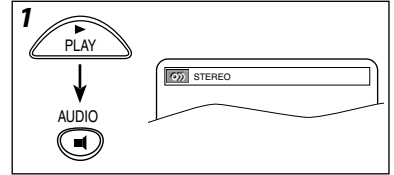

Each time you press [AUDIO], sound mode changes as example below.

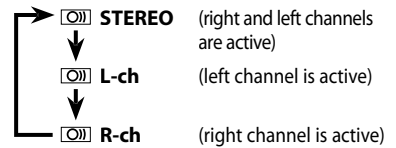

Virtual Surround



You can enjoy stereophonic virtual world on your existing 2 channel stereo system.

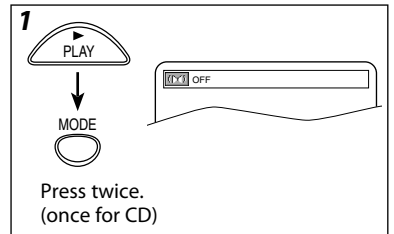

2 Press [ENTER] for the desired effect.

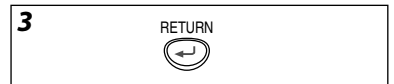
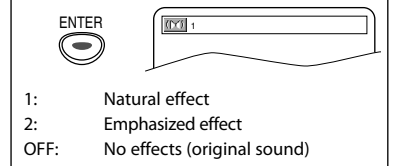

Hint

- For CD playback only
- Virtual Surround will not be effective if the sound mode is set to something other than STEREO. Refer to "Stereo Sound Mode".
- When playing back 96kHz with Virtual Surround function, the sound will be down sampling at 48kHz and output as digital audio.

QUICK SETUP Menu

You can select the "PLAYER MENU", "TV ASPECT" or "DOLBY DIGITAL" from the QUICK SETUP menu quickly.

1 Press [SETUP] in the stop mode.

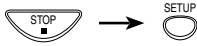

<SETUP MENU>

Confirm that "QUICK" is selected.

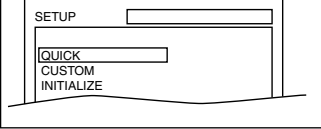

2 Select the desired item.

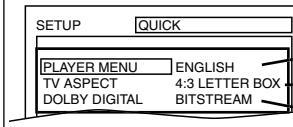

P20 **A** Step 5
 P21 **B** Step 5
 P21 **C** Step 5

• Refer to the sections "PLAYER MENU", "TV ASPECT" or "DOLBY DIGITAL" section on page 20 or 21.

CUSTOM Menu

You can change the settings of the unit.

• **QUICK** on pages 20-21 indicates DVD Setup menus also accessible from the QUICK SETUP menu.

1 Press [SETUP] in the stop mode.

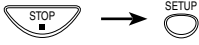

<SETUP MENU>

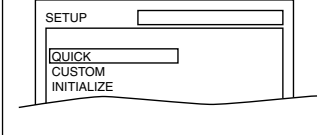

2 Select "CUSTOM".

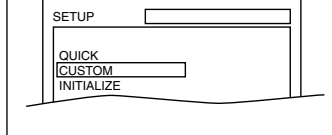
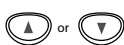

3 Select the desired item.

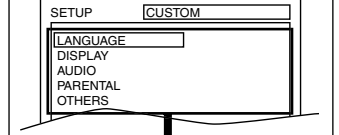

LANGUAGE menu

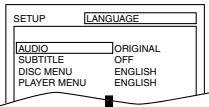

page 20 **A**

DISPLAY menu

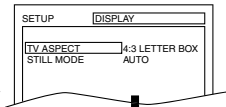

page 21 **B**

AUDIO menu

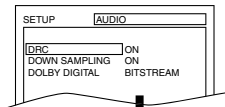

page 21 **C**

PARENTAL menu

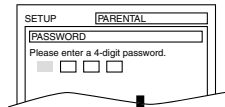

page 22 **D**

OTHERS menu

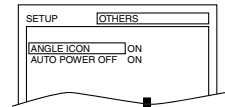

page 22 **E**

A LANGUAGE Setting

Follow steps 1 to 3 in the "CUSTOM Menu" section on above.

4 Select the desired item.

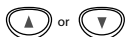

LANGUAGE menu

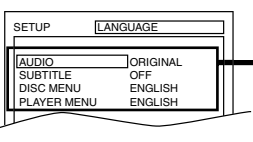

5 Select the desired language.

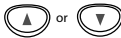

AUDIO: *1 *2
 (Default: ORIGINAL)
 Sets the audio language.

SUBTITLE: *1 *2
 (Default: OFF)
 Sets the subtitle language.

DISC MENU: *1
 (Default: ENGLISH)
 Sets the language for DVD menu.

PLAYER MENU: QUICK
 (Default: ENGLISH)
 Sets the language for the On-screen display.

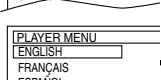
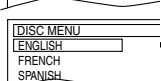
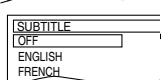
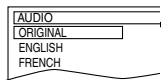

6 To exit the menu



Hint

- *1**
- Language options are not available with some discs.
 - If OTHER is selected on the AUDIO, SUBTITLE or DISC MENU screen, press four-digit number to enter the code for the desired language. (Refer to the language code list on page 24.)
 - Only the languages supported by the disc can be selected.
- *2**
- Language Setting for Audio and Subtitle are not available with some discs. Then use [AUDIO] and [SUBTITLE/T-SET]. Details are on page 19.

B DISPLAY Setting

You can change the display functions. Follow steps 1 to 3 in the "CUSTOM Menu" section on page 20.

4 Select the desired item.

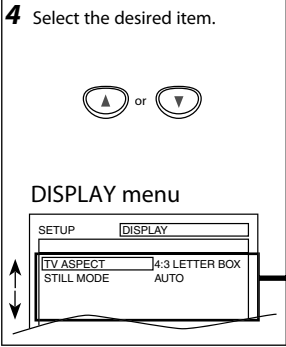

5

TV ASPECT: QUICK
(Default: 4:3 LETTER BOX)
See Hint on the right.

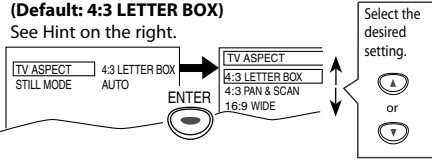

STILL MODE:
(Default: AUTO)
See Hint on the right.

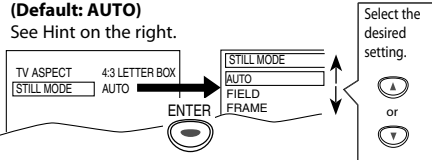

6 To exit the menu



Hint

TV ASPECT:

- Select "4:3 LETTER BOX", so that black bars may appear on the top and bottom of the screen.
- Select "4:3 PAN & SCAN" for a full height picture with both sides adjusted.
- Select "16:9 WIDE" if a wide-screen TV is connected to this unit.

STILL MODE:

- Select "AUTO" usually.
- If you select "AUTO", automatically select the best resolution setting (FRAME or FIELD) based on the data characteristics of the pictures. (default)
- If you select "FIELD", the picture in the still mode will be stabilized.
- If you select "FRAME", the picture in the still mode will be highly defined.
- An individual picture on TV screen is called a "frame", which consists of two separate images called as "field".
- Some pictures may be blurred if you select "AUTO" in the still mode due to their data characteristics.

C AUDIO Setting

Choose the appropriate audio settings for your equipment. It only affects during the playback of DVD discs. Follow steps 1 to 3 in the "CUSTOM Menu" section on page 20.

4 Select the desired item.

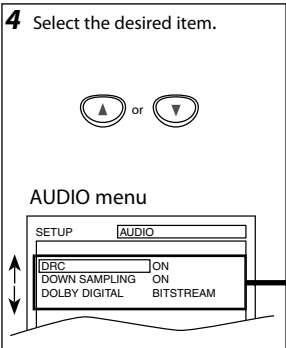

5

DRC (Dynamic Range Control):
(Default: ON)
Set to "ON" to compress the range between soft and loud sounds.

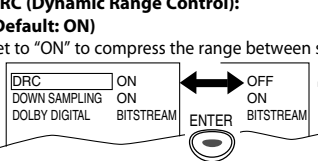

DOWN SAMPLING:
(Default: ON)
Set to "ON" when outputting in 48kHz.
Set to "OFF" when outputting the original sound.

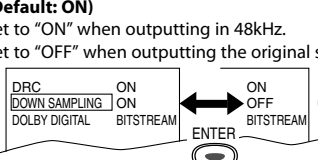

DOLBY DIGITAL: QUICK
(Default: BITSTREAM)
Set to "BITSTREAM" when the unit is connected to a Dolby Digital decoder.

- BITSTREAM: outputs a Dolby Digital Signals.
- PCM: converts the Dolby Digital into PCM (2 channel).

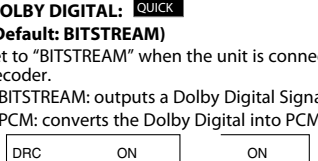

6 To exit the menu



Hint

DRC:

- This function is available only on the discs which are recorded in the Dolby Digital format.

DOWN SAMPLING:

- When playing back a 96kHz disc with the copyright protection, or when Virtual Surround is set to "1" or "2", the sound will be down sampled at 48kHz and output as digital audio even if the "DOWN SAMPLING" is set to "OFF".
- This function is available only on digital outputting of a disc recorded in 96kHz.

D PARENTAL Setting

Parental Control limits the disc viewing that exceed your settings. (An incorrect password will not be acceptable.) This feature prevents your children from viewing inappropriate materials.

Parental Levels

Parental Level allows you to set the rating levels of your DVD discs. Playback will stop if the ratings exceed the levels you set. Follow steps 1 to 3 in the "CUSTOM Menu" section on page 20.

4 Enter your desired four-digit password.

PARENTAL menu

SETUP PARENTAL

PASSWORD

Please enter a 4-digit password.

□ □ □ □

OR

If you have set a password already, enter the current four-digit password.

SETUP PARENTAL

PASSWORD

Enter current password.

□ □ □ □

5 Select "PARENTAL LEVEL".

CONTROL LEVELS

- ALL: All parental locks are cancelled.
- Level 8: DVD softwares of any grades (adult/general/children) can be played back. Only DVD softwares intended for general use and children can be played back.
- Levels 7 to 2: Only DVD softwares intended for general use and children can be played back.
- Level 1: Only DVD softwares intended for children can be played back, with those intended for adult and general use prohibited.

TIPS FOR LEVELS

- 8 [ADULT]: DVD softwares of any grades (adult/general/children) can be played back.
- 7 [NC-17]: No one under 17 admitted
- 6 [R]: Restricted; under 17 requires accompanying parent or adult guardian
- 5 [PGR]: Parental Guidance Recommended
- 4 [PG 13]: Unsuitable for children under 13
- 3 [PG]: Parental Guidance suggested
- 2 [G]: General Audience
- 1 [KID SAFE]: Suitable for children

Hint

- DVD-Video discs may not respond to the parental lock settings. Make sure this function works with your DVD-Video discs.

6 Select the desired level.

7 To exit the menu

To Change the Password for Parental Controls

You can change your password for parental controls. Follow steps 1 to 3 in the "CUSTOM Menu" section on page 20.

4 Enter current four-digit password.

PARENTAL menu

SETUP PARENTAL

PASSWORD

Enter current password.

□ □ □ □

5 Select "PASSWORD CHANGE".

6 Enter your new four-digit password (except for 4737).

SETUP PARENTAL

PASSWORD

Please enter a 4-digit password.

□ □ □ □

7 To exit the menu

Hint

- Record the password in case you forget it.
- If you forget the password, press [4], [7], [3], [7] at step 4, then enter your new password. Password will be cleared and parental levels will be set to "ALL".

E OTHERS Setting

You can change the other functions. Follow steps 1 to 3 in the "CUSTOM Menu" section on page 20.

4 Select the desired item.

OTHERS menu

SETUP OTHERS

ANGLE ICON ON

AUTO POWER OFF ON

5

ANGLE ICON: (Default: ON)

Set to "ON" to show the angle icon when multiple camera angles are available during DVD playback.

AUTO POWER OFF: (Default: ON)

Set to "ON" to turn this unit off automatically after 30 minutes of no use.

6 To exit the menu

Reset to the Default Setting (Except for PARENTAL Setting)

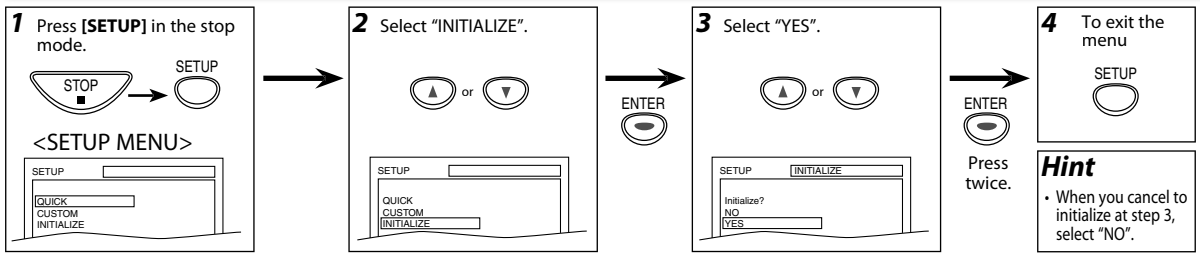

Information

Troubleshooting Guide

If this unit does not perform properly when operated as instructed in this Owner's Manual, check this unit consulting the following checklist.

	PROBLEM	CORRECTIVE ACTION
DVD / VCR	No power.	<ul style="list-style-type: none"> Make sure the power plug is connected to an AC outlet. Make sure the power is turned on.
	This unit does not respond to the remote control.	<ul style="list-style-type: none"> Check if the power plug is connected to an AC outlet. Check the batteries in the remote control. Aim the remote control directly at the remote sensor. If necessary, remove all the obstacles between the sensor and the remote control. You have to be within 23 feet (7m) of this unit. Check if the right mode is selected. If it's not in the right mode, press [DVD] or [VCR], whichever you need, on the remote control. Check if a cassette tape is in this unit. Tune your radio to an empty AM station so that you hear a lot of noises. Turn the volume up, then if you hear some signal sound from the radio in response to your pressing buttons on the remote control, the remote control is working.
	Poor picture or noise.	<ul style="list-style-type: none"> Interference signal may be received. Change the position and orientation of the unit.
VCR	Timer recording is impossible.	<ul style="list-style-type: none"> Make sure the Timer Recording is set correctly. Make sure TIMER REC indicator on the front panel lights up. If not, press [SUBTITLE/T-SET]. Make sure the VCR clock is set correctly.
	Cannot go into record mode.	<ul style="list-style-type: none"> Make sure the tape has a record tab. If needed, cover the hole with adhesive tape. Activate this unit in VCR mode. Press [VCR] on the remote control so that the VCR OUTPUT light is lit.
	Playback picture is partially noisy.	<ul style="list-style-type: none"> Adjust tracking control for a better picture by pressing [CHANNEL▼/▲] on the unit or [SKIP/CH.▶▶/▲, ◀◀/▼] on the remote control.
	Cannot view a tape but the audio is OK.	<ul style="list-style-type: none"> Head cleaning may be necessary. Refer to "AUTO HEAD CLEANING". Make sure the VCR is not in the Menu mode.
	No or poor, playback picture.	<ul style="list-style-type: none"> Change the RF output channel to CH4. Then select the same channel on the TV. Fine tune your TV.
	TV programs cannot be seen normally.	<ul style="list-style-type: none"> Re-check the ANT-IN and ANT-OUT connections. See the front page and page 6. Press [VCR]. Press [VCR] on the remote control to activate it in the VCR mode. Check if the VCR OUTPUT light is lit, then set it to the TV position by pressing [VCR].
	Video or color fades in and out when making a copy of a video tape.	<ul style="list-style-type: none"> You cannot copy a copyrighted video tape. You are experiencing copy guard protection.
Cannot remove the tape.	<ul style="list-style-type: none"> Check if this unit is in the VCR mode. If not, press [VCR] on the remote control to switch the mode. 	
DVD	No picture.	<ul style="list-style-type: none"> Connect the video cable firmly. Insert a correct video disc that plays on this unit. Press [DVD] on the remote control. Check if the DVD OUTPUT light is lit. Then try other DVD features.
	Disc cannot be played.	<ul style="list-style-type: none"> Insert the disc. Clean the disc. Place the disc correctly with the label side up. Cancel the parental lock or change the control levels. Handle a disc with special care so that it does not have fingerprints, scratches, or dusts on its surface.
	No sound.	<ul style="list-style-type: none"> Connect the audio cable firmly. Turn the power of the audio component on. Correct the audio output settings. Correct the input settings on the audio component.
	No DTS audio is output	<ul style="list-style-type: none"> This unit does not support DTS audio. This is not a malfunction.
	Distorted picture.	<ul style="list-style-type: none"> Connect this unit directly to the TV. There are some cases where pictures may be slightly distorted, and those are not a sign of a malfunction. Although pictures may stop for a moment, this is not a malfunction.
	Audio or subtitle language does not match the setup.	<ul style="list-style-type: none"> The selected language is not available for audio or subtitles on the DVD. This is not a malfunction.
	The camera angle cannot be changed.	<ul style="list-style-type: none"> The DVD does not contain sequences recorded from different camera angles. This is not a malfunction.
	Audio or subtitle language cannot be changed.	<ul style="list-style-type: none"> The DVD does not contain audio source or subtitles in the selected language. This is not a malfunction.
	"Prohibited icon" appears on the screen, prohibiting an operation.	<ul style="list-style-type: none"> That operation is prohibited by this unit or the disc. This is not a malfunction.

- Some functions are not available in specific modes, but this is not a malfunction. Read the description in this Owner's Manual for details on correct operations.
- Playback from a desired track and random playback are not available during program playback.
- Some functions are prohibited on some discs.

Specifications

Video Heads :
Four Heads
Output signal format :
NTSC color
Power source :
120 V AC +/- 10%, 60 Hz +/- 0.5%
Power consumption :
18 W (standby: 2.8W)

Operating temperature :
41°F (5°C) to 104°F (40°C)
Dimensions :
W : 17 3/16" (435mm)
H : 3 3/4" (94mm)
D : 9 3/16" (233mm)
Weight :
Approx 6.0lbs (2.7kg)

- Designs and specifications are subject to change without notice.
- If there is a discrepancy between languages, the default language will be English.

Language Code List

Language	Code	Language	Code	Language	Code	Language	Code
	A-B						
Abkhazian	4748	French [FRE]	5264	Macedonian	5957	Siswat	6565
Afar	4747	Frisian	5271	Malagasy	5953	Slovak [SLO]	6557
Afrikaans	4752	Galician	5358	Malay	5965	Slovenian	6558
Albanian	6563	Georgian	5747	Malayalam	5958	Somali	6561
Amharic	4759	German [GER]	5051	Maltese	5966	Spanish [SPA]	5165
Arabic	4764	Greek [GRE]	5158	Maori	5955	Sundanese	6567
Armenian	5471	Greenlandic	5758	Marathi	5964	Swahili	6569
Assamese	4765	Guarani	5360	Moldavian	5961	Swedish [SWE]	6568
Aymara	4771	Gujarati	5367	Mongolian	5960		
Azerbaijani	4772	Hausa	5447	Nauru	6047	T	
Bashkir	4847	Hebrew	5569	Nepali	6051	Tagalog	6658
Basque	5167	Hindi	5455	Norwegian [NOR]	6061	Tajik	6653
Bengali;Bangla	4860	Hungarian [HUN]	5467			Tamil	6647
Bhutani	5072			O-R		Tatar	6666
Bihari	4854	Icelandic [ICE]	5565	Occitan	6149	Telugu	6651
Bislama	4855	Indonesian	5560	Oriya	6164	Thai	6654
Breton	4864	Interlingua	5547	Oromo(Afan)	6159	Tibetan	4861
Bulgarian [BUL]	4853	Interlingue	5551	Panjabi	6247	Tigrinya	6655
Burmese	5971	Inupiak	5557	Pashoto;Pushoto	6265	Tonga	6661
Byelorussian	4851	Irish [IRI]	5347	Persian	5247	Tsonga	6665
		Italian [ITA]	5566	Polish [POL]	6258	Turkish [TUR]	6664
		Japanese [JPN]	5647	Portuguese [POR]	6266	Turkmen	6657
		Javanese	5669	Quechua	6367	Twi	6669
		Kannada	5760	Rhaeto-Romance	6459		
		Kashmiri	5765	Romanian [RUM]	6461	U-Z	
		Kazakh	5757	Russian [RUS]	6467	Ukrainian	6757
		Kinyarwanda	6469			Urdu	6764
		Kirghiz	5771	S		Uzbek	6772
		Kirundi	6460	Samoan	6559	Vietnamese	6855
		Korean [KOR]	5761	Sangho	6553	Volapuk	6861
		Kurdish	5767	Sanskrit	6547	Welsh	4971
				Scots Gaelic	5350	Wolof	6961
		L-N		Serbian	6564	Xhosa	7054
		Laothian	5861	Serbo-Croatian	6554	Yiddish	5655
		Latin	5847	Sesotho	6566	Yoruba	7161
		Latvian;Lettish	5868	Setswana	6660	Zulu	7267
		Lingala	5860	Shona	6560		
		Lithuanian	5866	Sindhi	6550		
				Singhalese	6555		

If you choose a Language that has a 3 letter language code, the code will be displayed every time you change the Audio or Subtitle language setting on page 19. If you choose any other languages, "--" will be displayed instead. (3 letter language code is written in bracket.)

MAGNAVOX LIMITED WARRANTY

FUNAI CORP. will repair this product, free of charge in the CANADA in the event of defect in materials or workmanship as follows:

DURATION:

PARTS: FUNAI CORP. will provide parts to replace defective parts without charge for one (1) year from the date of original retail purchase. Certain parts are excluded from this warranty.

LABOR: FUNAI CORP. will provide the labor without charge for a period of ninety (90) days from the date of original retail purchase.

LIMITS AND EXCLUSIONS:

This warranty is extended only to the original retail purchaser. A purchase receipt or other proof of original retail purchase will be required together with the product to obtain service under this warranty.

This warranty shall not be extended to any other person or transferee.

This warranty is void and of no effect if any serial numbers on the product are altered, replaced, defaced, missing or if service was attempted by an unauthorized service center. This limited warranty does not apply to any product not purchased and used in CANADA.

This product is produced for home use and this warranty only covers failures due to defects in material or workmanship which occurs during normal use. It does not cover damage which occurs in shipment, or failures which are caused by repairs, alterations or product not supplied by FUNAI CORP., or damage which results from accident, misuse, abuse, mishandling, misapplication, alteration, faulty installation, improper maintenance, commercial use such as hotel, rental or office use of this product or damage which results from fire, flood, lightning or other acts of God.

THIS WARRANTY DOES NOT COVER PACKING MATERIALS, ANY ACCESSORIES (EXCEPT REMOTE CONTROL), ANY COSMETIC PARTS, COMPLETE ASSEMBLY PARTS, DEMO OR FLOOR MODELS.

FUNAI CORP. AND ITS REPRESENTATIVES OR AGENTS SHALL IN NO EVENT BE LIABLE FOR ANY GENERAL, INDIRECT OR CONSEQUENTIAL

DAMAGES ARISING OUT OF OR OCCASIONED BY THE USE OF OR THE INABILITY

TO USE THIS PRODUCT. THIS WARRANTY IS MADE IN LIEU OF ALL OTHER WARRANTIES, EXPRESS OR IMPLIED, AND OF ALL OTHER LIABILITIES ON THE PART OF FUNAI. ALL OTHER WARRANTIES INCLUDING THE WARRANTY OF MERCHANTABILITY, AND FITNESS FOR A PARTICULAR PURPOSE, ARE HEREBY DISCLAIMED BY FUNAI AND ITS REPRESENTATIVES IN CANADA. ALL WARRANTY INSPECTIONS AND REPAIRS MUST BE PERFORMED BY AN AUTHORIZED SERVICE CENTER. THIS WARRANTY IS VALID WHEN THE UNIT IS CARRIED-IN TO AN AUTHORIZED SERVICE CENTER.

IMPORTANT:

THIS LIMITED WARRANTY GIVES YOU SPECIFIC LEGAL RIGHTS. YOU MAY HAVE OTHER RIGHTS THAT VARY FROM STATE TO STATE. IF, AT ANY TIME DURING THE WARRANTY PERIOD, YOU ARE UNABLE TO OBTAIN SATISFACTION WITH THE REPAIR OF THIS PRODUCT, PLEASE CONTACT FUNAI CORP.

ATTENTION:

FUNAI CORP. RESERVES THE RIGHT TO MODIFY ANY DESIGN OF THIS PRODUCT WITHOUT PRIOR NOTICE.

WARRANTY STATEMENT REGARDING NON AUTHORIZED REPAIRS:

To obtain warranty service, you must take the product, or deliver the product freight prepaid, in either its original packaging or packaging affording an equal degree of protection, to any AUTHORIZED SERVICE CENTER. FUNAI CORP. will not reimburse you for any service done by unauthorized service providers without prior written approval.

To locate your nearest AUTHORIZED SERVICE CENTER or for general service inquiries, please contact us at:

FUNAI SERVICE CORPORATION
Tel: 1-800-605-8610

www.magnavox.com/support
2200 Spiegel Drive, Groveport, OH 43125

Quick Use Guide

1 Connections

Please refer to "Basic TV Connection" on the front page before you use this unit.

RF Output Channel

If channel 3 has been already occupied for broadcasting,

- 1) Set your TV to channel 4.
- 2) Insert a pre-recorded tape into this unit.
- 3) Press **[SOURCE]** on the unit so that the VCR SOURCE light is lit.
 - If noise appears on the TV screen, press **[VCR/TV]** on the remote control.
- 4) Press **[PLAY ▶]** once.
- 5) After a few seconds, press and hold **[PLAY ▶]** on the unit for 3 seconds.
 - The RF output channel will change to channel 4 from channel 3 and you will see a playback picture.
 - When a picture does not appear on the TV screen, repeat step 4.
- 6) Press **[STOP ■]** to stop playback.

2 Installing the Batteries for the Remote Control

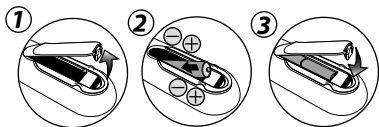

3 VCR/DVD Switching

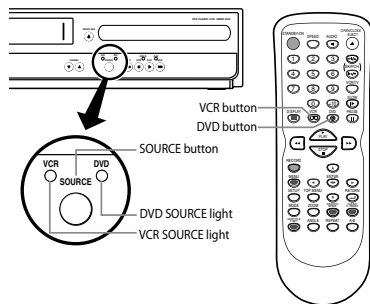

VCR MODE

Press **[VCR]** on the remote control. (Verify that the VCR SOURCE light is lit.)

DVD MODE

Press **[DVD]** on the remote control. (Verify that the DVD SOURCE light is lit.)

Hint

- Pressing only **[SOURCE]** on the front panel DOES NOT switch the mode of the remote control. You MUST select the correct mode on the remote control.

4 Turn on the Unit for the First Time



- 1 Turn on the TV and set it to channel 3.
 - If channel 3 has been already occupied for broadcasting, see "RF Output Channel" section.



- 2 Select your language when turning this unit on for the first time. Then press **[▶]** to go to next step.

STANDBY-ON

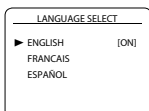
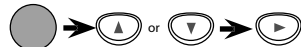

- 3 Press **[▶]** to start Auto Set Up.

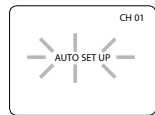

Do you connect the cable from the cable box or the satellite box to the unit's ANT-IN jack?

YES

NO

Yes Press **[MENU]** to exit.

No Please wait for a few minutes. After scanning...

- The tuner stops on the lowest memorized channel.
- You can select only the channels memorized in this unit by using **[SKIP/CH. ▶▶/▲, ◀◀/▼]** (or **[CHANNEL ▲/▼]**).
- If "AUTO SET UP" appears on the TV screen again, check the cable connections. Then, press **[▶]** once again.

5 Clock Setup



- 1 Press **[MENU]** and select "CLOCK SET". Then press **[▶]** to go to next step.

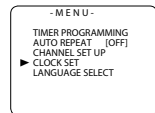

- If the clock is not set, the CLOCK SET screen appears when you press **[MENU]**. In this case, go to step 2.

- 2 Select the current month. Then press **[▶]** to go to next step.

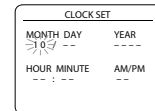

- 3 Select the current day. Then press **[▶]** to go to next step.

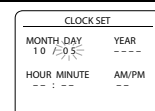

- 4 Select the current year. Then press **[▶]** to go to next step.

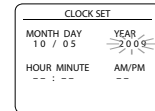

- 5 Select the current hour. Then press **[▶]** to go to next step.

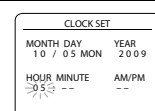

- 6 Select the current minute. Then press **[▶]** to go to next step.

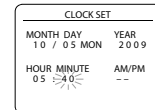

- 7 Select "AM" or "PM".

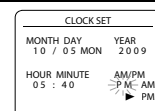
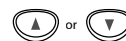

- 8 To exit the CLOCK SET screen



cut here

Quick Use Guide

6 VCR Playback

Before: Turn on the TV and set it to channel 3.
 • If channel 3 has been already occupied for broadcasting, see "RF Output Channel" section.



1 Insert a video cassette into this unit. 	2 To start playback
3 To stop playback 	4 To eject the cassette

7 DVD/CD Playback

Before: Turn on the TV, amplifier and any other components which are connected to this unit. Make sure the TV and audio receiver (commercially available) are set to the correct channel.



1 →	2 Insert a disc with label facing up.
3 To start playback 	4 To stop playback

8 Remote Control

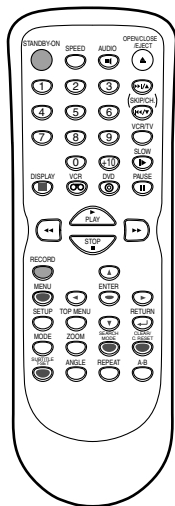

Button (Alphabetical order)	Disc/Tape	DVD mode		VCR mode
		DVD	CD	VHS
1-10		• To select chapter or title directly.	• To select track directly.	• To select channel. • The +10 button has no effect in VCR mode.
◀ ▶		• To search forward/backward through a disc. • To begin slow forward playback in the pause mode.	• To search forward/backward through a disc.	• To forward/backward a tape.
A-B		• To repeat between your chosen point of A and B.	• To repeat between your chosen point of A and B.	—
ANGLE		• To select camera angles on a disc.	—	—
AUDIO		• To select audio languages on a disc.	• To select STEREO, L-ch or R-ch.	—
CLEAR/C RESET		• To remove status number in program input. • To clear the numbers entered incorrectly. • To cancel the point for A-B repeat.	• To remove status number in program input. • To clear the numbers entered incorrectly. • To cancel the point for A-B repeat.	• To exit the VCR Menu. • To reset the tape counter.
DISPLAY		• To display the current disc mode.	• To display the current disc mode.	• To display the current time, tape counter, and channel.
DVD		• To select the DVD output mode. • To activate the remote control in DVD mode.	• To select the DVD output mode. • To activate the remote control in DVD mode.	—
ENTER		• To move the cursor and determine its position.	• To move the cursor and determine its position.	 • To select an item on the VCR Menu. • To advance to the next VCR Menu. • To go back one step during clock and timer setting.
MENU		• To call up the Menu on a disc.	—	• To call up the VCR Menu.
MODE		• To arrange the playing order or play randomly. • To set black level on/off. • To set virtual surround on/off.	• To arrange the playing order or play randomly. • To set virtual surround on/off.	—
OPEN/CLOSE EJECT		• To open or close the disc tray.	• To open or close the disc tray.	• To eject the video cassette from the VCR.
PAUSE		• To pause disc playback. • To advance playback one frame at a time.	• To pause disc playback.	• To pause tape playback or recording. • To advance playback one frame at a time.
▶		• To begin disc playback.	• To begin disc playback.	• To begin tape playback.
RECORD		—	—	• To start a recording or One Touch Recording.
REPEAT		• To play a chapter or title repeatedly.	• To play a track or disc repeatedly.	—
RETURN		• To return to the previous operation in menu.	• To return to the previous operation in menu.	—
SEARCH MODE		• To search chapter, title or time. • To set or search the markers.	• To search track. • To search time. • To set or search the markers.	• To call up the index or time search menu.
SETUP		• To call up the DVD setup menu.	• To call up the DVD setup menu.	—
SKIP/CH. SKIP/CH.		• To skip chapters or titles.	• To skip tracks.	• To change channels. • To adjust the tracking manually during playback.
SLOW		—	—	• To view the tape in slow motion.
SPEED		—	—	• To select the recording speed.
STANDBY-ON		• To turn the unit on or to turn the unit into the standby mode. (To completely turn off the unit, you must unplug the AC power cord.)	• To turn the unit on or to turn the unit into the standby mode. (To completely turn off the unit, you must unplug the AC power cord.)	• To turn the unit on or to turn the unit into the standby mode. (To completely turn off the unit, you must unplug the AC power cord.)
STOP		• To stop playback.	• To stop playback.	• To stop playback or recording.
SUBTITLE T-SET		• To select subtitles on a disc.	—	• To put the VCR into standby mode for a Timer Recording.
TOP MENU		• To call up the Top Menu on a disc.	—	—
VCR		—	—	• To select the VCR output mode. • To activate the remote control in VCR mode.
VCR/TV		• To select DVD position or TV position.	• To select CD position or TV position.	• To select VCR position or TV position.
ZOOM		• To magnify part of a picture. (x2 / x4)	—	—

cut here